

INT



Contents



About us



Receptacles



Plugs and connectors



Receptacle combinations



Extended versions
and special devices



Data- / network technology



Application-specific solutions



Service

MENNEKES – The company.



When my grandfather, Aloys Mennekes, received his Master Electrician's certificate in 1935, he surely was not aware of what would develop from his commitment to electrical engineering. At that time, he knew only one thing: he wanted to put his ideas into practice and manufacture his own products.

As you leaf through the pages of this catalogue, you get a feeling of how strongly this initial entrepreneurial desire continues to design us today. The variety of the products on display clearly shows that we still have great pleasure in converting our ideas into new products. But marketable ideas are rarely generated behind closed doors. As specialists, we therefore develop individual solutions together with our customers. Hence our product portfolio today consists of more than 10,000 customised products, far more than we can show in this catalogue.

Since it was founded over 80 years ago, MENNEKES has been a wholly owned family business, responsibly managed by members of the owner family throughout. Responsibility for the Company also means responsibility for the people who are at the heart of our thinking and actions at MENNEKES.

Through their awareness of the values of diligence, reliability and loyalty, they constitute an important cornerstone of the Company.

I am proud to be able to continue this tradition in the third generation.

These are fascinating times for the preservation of tradition because, due to the digital revolution, many things are going to change in the next decade. In this world flooded with information, MENNEKES wants to be a point of reference on which our customers can rely for quality, safety and functionality. We say with confidence: Our brand is a promise.

Thank you for believing this promise and thus supporting our business philosophy.

Christopher Mennekes
General Management Director

„I am proud to be able to continue this tradition in the third generation.“

Christopher Mennekes, General Management Director

MENNEKES – The company.

A regionally rooted family business that is globally networked

At MENNEKES, being rooted in the region and transnationality work hand in glove: we are an independent medium-sized company that has been family-owned for well over 80 years. Managed by the third family generation, MENNEKES is committed to its home in the Sauerland region and Germany as its business location. Kirchundem/Sauerland has been MENNEKES headquarters ever since the business was founded in 1935. A second location in Sehmetal-Neudorf/Erzgebirge in Saxony was opened in 1991. Our in-house tool making, MIDENA Elektrowerkzeugbau GmbH, has been operating in Lennestadt in the Sauerland region since 2000. MENNEKES' products meet the "Made in Germany" quality standard. Our solutions are sold in more than 90 countries and our network of subsidiaries, sales offices and representations spans from Europe, Asia, and the Middle East to North and South America.



Aloys Mennekes (center) with apprentice and journeymen on their way to work.



Plugs and sockets for toughest conditions



Family Mennekes (from left): Petra and Walter, Daniela and Christopher and Michael and Steffen

Quality "Made in Germany" – tested under extreme conditions.



When a MENNEKES product leaves our factory, it has already survived the harshest testing. In our test lab it is exposed to cold, heat, dust and water over and over again. Only the products that withstand these tests are worthy of the name MENNEKES. Our products are of course certified to national and international standards by recognised institutions. Like the MENNEKES company itself: Our international quality management system is certified to ISO 9001.

Independent test organizations certify that our products offer the highest levels of safety, quality and troublefree use.



Quality "Made in Germany" – tested under extreme conditions.

Only the combination of first-class materials and advanced manufacturing processes guarantees a premium product. This is why we use only first-grade plastics which are processed by a highly skilled workforce in state-of-the-art production facilities to create certified MENNEKES products.

We guarantee the high quality standard of our products by our own test laboratory. This laboratory is approved and will be used for product tests of our products to get test marks acc. to IEC 60309 by approval authorities like the VDE etc.



<h3>ZERTIFIKAT</h3> <p>CERTIFICATE</p> <p>für stückgeprüfte Qualität nach DIN EN 61439.</p> <p>for individually tested quality according to IEC 61439.</p> <div style="border: 1px solid black; height: 30px; width: 100%;"></div> <p><small>Hiermit bestätigen wir, dass diese Steckdose-Kombination einer Stückprüfung unterzogen wurde. Hereby we confirm that this receptacle combination has passed a routine test.</small></p> <p><small>Der MENNEKES-Sicherheitsleitfaden berücksichtigt nicht nur die elektrischen Prüfanforderungen nach DIN EN 61439, sondern beinhaltet darüber hinaus auch eine übliche Hochspannungsprüfung. The MENNEKES safety test not just include the requirements for electrical tests acc. to IEC 61439 but also a high voltage test for all poles.</small></p> <p><i>Dietmar Löcker</i> Dietmar Löcker Bereichsleiter Qualität / Division Manager Quality</p>	
<p><small>MENNEKES Elektrotechnik GmbH & Co. KG Alteps-Merwiese-Strasse 1 53799 KIRCHHELDEN / GERMANY</small></p>	<p><small>Phone: +49 2723 41-1 Fax: +49 2723 41-214 www.MENNEKES.de</small></p>

Based out of Germany, at home in the world.

We are close to our customers everywhere. We take care of our German market with an experienced sales team, qualified field teams, and a nationwide network of sales representatives. Our international sales experts, representatives, subsidiaries and sales offices represent the MENNEKES brand in over 90 countries. 1,600 employees ensure the highest quality and best service every day. You can rely on us.

Subsidiaries:

- USA
- Great Britain
- France
- Italy
- Netherlands
- Romania
- India
- China
- Singapore

Sales offices and regional country managers:

- Denmark
- Norway
- Sweden
- Netherlands
- Bahrain for the Middle East
- South Korea
- Indonesia
- Malaysia
- Thailand
- Vietnam

Representatives:

- 11 in Germany
- 31 in Europe with local specialist partners (e.g. in Austria, Switzerland, Belgium, Spain and Poland)
- 46 outside of Europe with local specialist partners (e.g. in Japan, Brazil, Peru, Australia and South Africa)

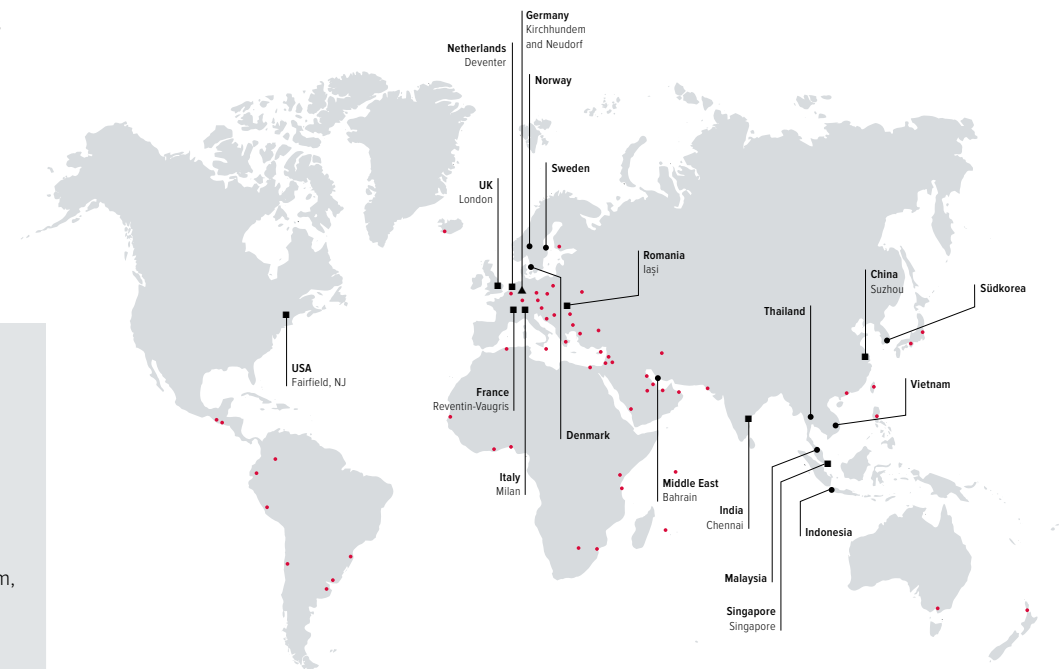

▲ Head office Germany ■ Subsidiaries ● Sales offices and regional country managers ● Agencies with local partners

Contact persons – at MENNEKES.

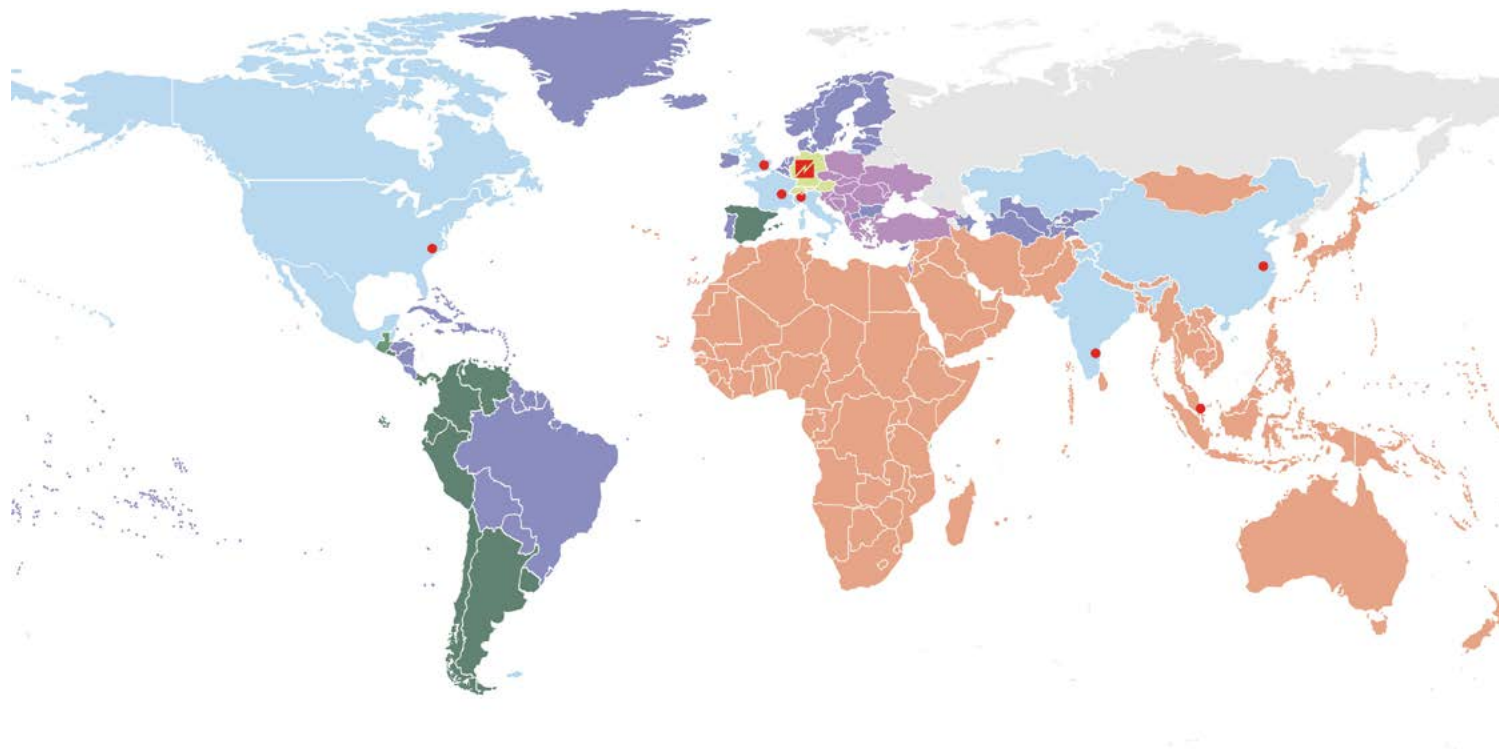

● ● ● ● ● **Karsten Hauck** Head of International Sales
Phone: +49 2723 41-281
karsten.hauck@MENNEKES.de

● **Andrea Garte** Head of Regional Sales
Phone: +49 2723 41-234
andrea.garte@MENNEKES.de

● **Jörg Schneider** Head of Regional Sales
Phone: +49 2723 41-232
joerg.schneider@MENNEKES.de

● **Karsten Hauck** Head of International Sales
Phone: +49 2723 41-281
karsten.hauck@MENNEKES.de

● **Carsten Gabler** Area Sales Manager
Phone: +49 2723 41-659
carsten.gabler@MENNEKES.de

● **René Fischer** Area Sales Manager
Phone: +49 2723 41-240
rene.fischer@MENNEKES.de

● **Michael Schäfer** Head of Sales (DE-AT-CH-LU)
Phone: +49 2723 41-245
michael.schaefer@MENNEKES.de

Contact persons

You will find the contact information of our contact persons and our subsidiaries on our website www.MENNEKES.org

X-CONTACT – Future is now. The new generation of contact sleeves.

As a specialist for plugs and sockets MENNEKES is known all over the world for setting standards. In the past few years, we dealt intensively with current requirements of the electric mobility and automotive sectors. We used the know-how gained to develop a completely new contact sleeve solution for industrial connectors and receptacles: X-CONTACT

Better contact

It is important to achieve the best possible balance between a safe contact closure and ease of insertion. We have successfully implemented this with X-CONTACT in an entirely new way. This technology is already used in all of our sockets in 63 A and 125 A, our PowerTOP Xtra connectors in 16 to 125 A and our DUO wall mounted receptacle in 16 and 32 A.

Due to a completely new manufacturing process, the X-CONTACT sleeve obtains resilient properties based solely on its material characteristics, without the need to use any additional spring elements. Thanks to the shape of the X-CONTACT sleeve, a particularly safe contact closure can be achieved.

Less effort

The special design of the X-CONTACT reduces the effort of insertion and withdrawal by up to 50 %. An advantage that simplifies work processes and improves safety especially with high electrical currents. With X-CONTACT, MENNEKES creates a safe contact closure and easy handling at a new, equally high level. But how does X-CONTACT achieve these benefits even with currents of 63 A or 125 A? A glance into the opening of an X-CONTACT sleeve reveals the intelligent functional principle: the X-shaped slot and groove in the inner wall provides four advantages of the new design: innovative, simple, durable and safe. We call it the X principle.

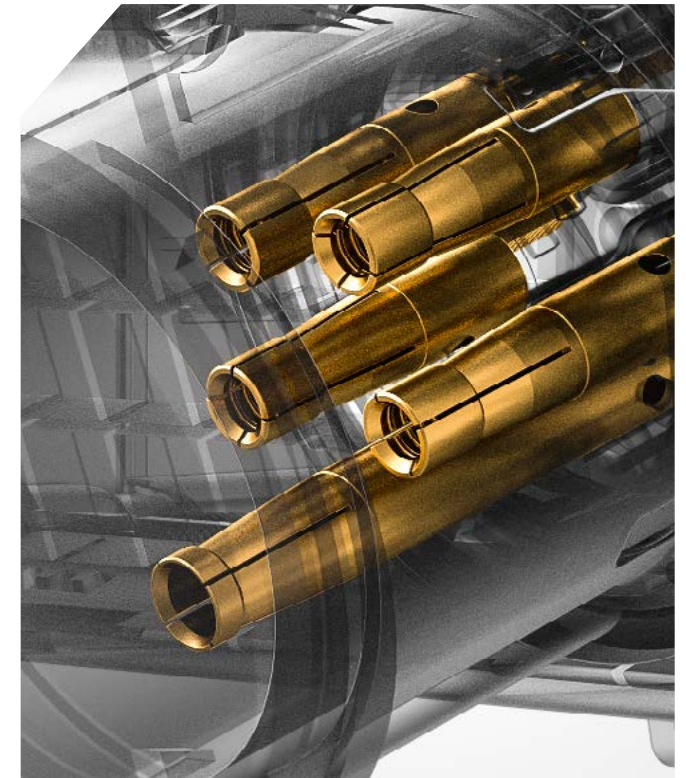

X-CONTACT –

In our 63 A and 125 A wall mounted and panel mounted receptacles and our DUO wall mounted receptacles in 16 and 32 A.

Innovative

Due to the slotted sleeves with their resilient material properties, X-CONTACT is the simplest possible mechanical solution: the plug pin simply expands the opening of the resilient contact sleeve, which reduces the force needed to connect and disconnect the plug by up to 50 %.

X-CONTACT – intelligently innovative!

Durable

Even in cases when the plug is connected and disconnected frequently, there are no signs of wear and the sleeve material remains fatigue-proof in the long term even after rough handling. Due to the quality of the new sleeves, contamination and surface corrosion is automatically removed by connecting and disconnecting.

X-CONTACT – lasting solution!

Simple

In practice, X-CONTACT simplifies work processes. The connection can now be handled by one person even with a current of 125 A, while conventional contact sleeves required two persons to connect and disconnect.

X-CONTACT – simply brilliant!

Safe

A higher degree of safety of handling is provided by the easier connection and disconnection. The groove within the inner wall in connection with the resilient material of the contact sleeves provides for a safe contact closure.

X-CONTACT – double safety!



TwinCONTACT – The swift connection.



Looking for quick and easy connection?

You can't miss the MENNEKES TwinCONTACT – a spring terminal in a newly designed receptacle. Remove the insulation, insert the conductors, and you're done. The contact is safely held in place and it is even approved as a connection terminal. Releasing the conductor is just as easy: Press the red button and remove the conductor – this is our concept of convenient and time-saving handling.

Suitable for solid conductors and flexible conductors (with end sleeve for strands, crimped so as to be gas-tight or ultrasonically welded).
Cond. cross section:
at 16 A: 1.5 - 4.0 mm²
at 32 A: 2.5 - 10.0 mm²



Colour-coded terminals for unmistakable connections.

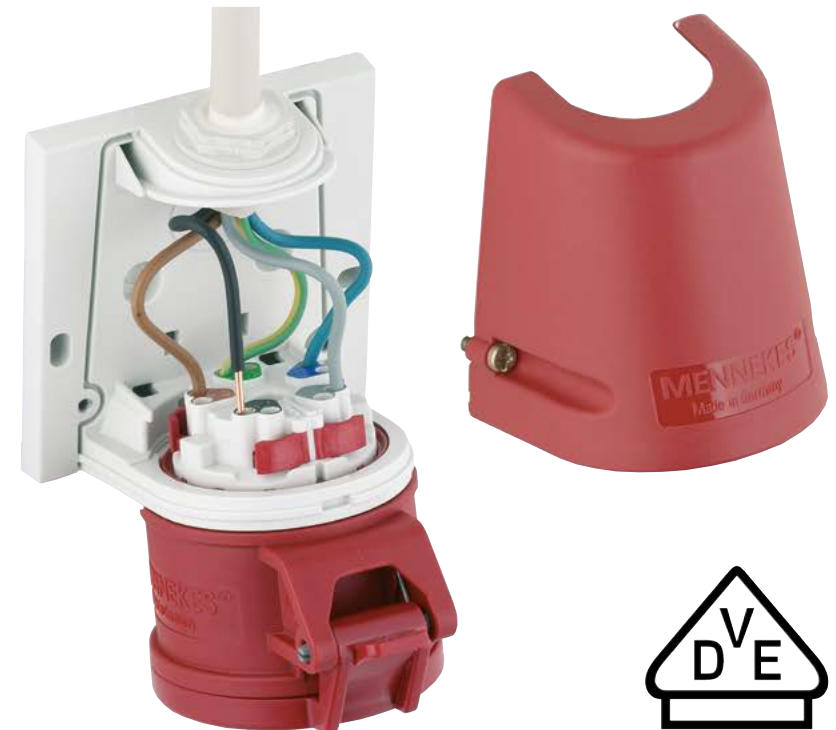

DUOi wall mounted receptacles

The new switched and interlocked wall mounted receptacle in 16 and 32 A with voltage indicator.

NEW



Machines and systems operate day and night, conveyor belts run without pause and cranes work nonstop to lift and carry materials weighing tons. Container ports, shipyards, factories, mines, food processing and warehouses are always bustling with activity. Everywhere there's a need for safe reliable power in order to work smoothly and cost-effectively.

This is where our switched and interlocked DUO wall mounted receptacles come in. They've been popular for years across a wide variety of industries and applications. Now we've completely redesigned and optimised this family of receptacles, which come in 16 A and 32 A versions with 3, 4, or 5 poles. The result is the DUOi wall mounted receptacle with fantastic new features. See for yourself!



DUOi wall mounted receptacles

The new switched and interlocked wall mounted receptacle in 16 and 32 A with voltage indicator.

NEW

Always keeping an eye on the operating status

Our switched and interlocked wall mounted receptacle DUOi comes with an LED voltage indicator. This is prominently positioned above the switch and shows you the current status of the device. This way, you always have the operating status of the DUOi receptacle in front of you: When the outlet is switched on and operating in normal working mode, the indicator lights up green. When it is switched off or an error occurs, the indicator goes out – allowing you to quickly react and promptly address any issues.



Practical aperture with hinged lid

For comfortable use and reliable operation without mishaps: the receptacle's hinged cap is easy to open and close. It opens upward instead of toward the wall. This prevents collisions with connected cables and cable glands.

Lockout/tagout padlock for additional protection

Do you need to play it absolutely safe? The selector knob of every DUOi wall mounted receptacle's switch has a hole for attaching your own lockout/tagout padlock. This gives you added safety by preventing the switch from being unintentionally turned on when a plug is in the receptacle. The result is complete safety, for example for carrying out maintenance tasks. It's impossible for current to be unintentionally delivered to machines or other equipment – essential for preventing accidents.





Practical mounting plate

The mounting plate is removable for easy cable installation. The receptacle and switch disconnecter are on the mounting plate and come prewired. You can also easily remove the mounting plate with the receptacle and switch as a single unit at any time, for example to place them on a firm surface for maintenance work.



to IEC 60309-2, EN IEC 60309-2, DIN EN IEC 60309-2 (VDE 0623-2). Other voltages and frequencies available on request. Products with pilot contact available on request.

PRODUCT INFORMATION

	A	P	110 V	230 V	400 V	500 V	>50 - 500 V												
			50 a. 60 Hz			50 a. 60 Hz			50 a. 60 Hz			100-300 Hz			300-500 Hz				
			3 p	4 p	5 p	3 p	4 p	5 p	3 p	4 p	5 p	3 p	4 p	5 p	3 p	4 p	5 p		
			4 h	4 h	4 h	6 h	9 h	9 h	9 h	6 h	6 h	7 h	7 h	7 h	10 h	10 h	10 h	2 h	2 h
 <p>Wall mounted receptacle external fixing, cable entry at top</p> <p>IP44 Std. Pack: 10</p>	16	3		27001															
	16	4			27002	27003													
	16	5			27004														
	32	3		27005															
	32	4			27006	27007													
	32	5			27008														
 <p>Wall mounted receptacle internal fixing, enclosure base can be turned 180°, receptacles are designed for adding an auxiliary contact switch, one cable entry at top, two blind cable entries (can be cut out) at bottom</p> <p>IP44 Std. Pack: 10</p>	16	4	3030	3034	1418	3032	3035	3028											
	16	5		3045	1419	3043	3046	3039											
	32	3	1420	1421	1422			3134											
	32	4	1423	1424	1425	1426	1427												
	32	5		1556	1557	3152	3154	3149											
 <p>Wall mounted receptacle X-CONTACT, suitable for through wiring, internal fixing, enclosure base can be turned 180°, highly heat resistant contact carrier, with 6 fixing points to accommodate special terminals</p> <p>IP44 Std. Pack: 5</p>	63	3	1136A	1137A															
	63	4		1140A	1141A	1142A													
	63	5		1144A	1145A														

to IEC 60309-2, EN IEC 60309-2, DIN EN IEC 60309-2 (VDE 0623-2). Highly resistant to chemicals. Other voltages and frequencies available on request.
 Products with pilot contact available on request.

PRODUCT INFORMATION

	A	P	110 V	230 V	400 V	500 V	>50 - 500 V								
			50 a. 60 Hz			50 a. 60 Hz			50 a. 60 Hz			100-300 Hz		300-500 Hz	
			3 p	4 p	5 p	3 p	4 p	5 p	3 p	4 p	5 p	3 p	4 p	5 p	
 <p>Wall mounted receptacle highly resistant to chemicals, with 2 external fixing points, enclosure base can be turned 180°, receptacles are designed for adding an auxiliary contact switch</p> <p>IP67 Std. Pack: 10</p>	16	3	9300	9301	9302										
	16	4		9321	9322	9323	9324								
	16	5		9341	9342										
	32	3	9350	9351	9352										
	32	4		9371	9372	9373									
	32	5	9380	9381	9382										
 <p>Wall mounted receptacle X-CONTACT, internal fixing, enclosure base can be turned 180°, with 6 fixing points to accommodate special terminals</p> <p>IP67 Std. Pack: 5</p>	63	3	856	128A	129A										
	63	4		131A	132A	133A									
	63	5	134A	135A	136A	2007A									
 <p>Wall mounted receptacle X-CONTACT, highly resistant to chemicals, highly heat resistant contact carrier, nickel plated contacts, internal fixing, enclosure base can be turned 180°</p> <p>IP67 Std. Pack: 5</p>	63	5			3774										



to IEC 60309-2, EN IEC 60309-2, DIN EN IEC 60309-2 (VDE 0623-2). Other voltages and frequencies available on request. Products with pilot contact available on request.

PRODUCT INFORMATION

		A	P	110 V	230 V	400 V	500 V	>50 - 500 V					
				50 a. 60 Hz	50 a. 60 Hz	50 a. 60 Hz	50 a. 60 Hz	100-300 Hz			300-500 Hz		
				3 p 4 p 5 p	3 p 4 p 5 p	3 p 4 p 5 p	3 p 4 p 5 p	3 p 4 p 5 p	3 p 4 p 5 p	3 p 4 p 5 p	3 p 4 p 5 p	3 p 4 p 5 p	3 p 4 p 5 p
				4 h 4 h 4 h	6 h 9 h 9 h	9 h 6 h 6 h	7 h 7 h 7 h	10 h 10 h 10 h	10 h 2 h 2 h	10 h 2 h 2 h	10 h 2 h 2 h	10 h 2 h 2 h	10 h 2 h 2 h
	Wall mounted receptacle X-CONTACT	125	4	137	138	139	140						
		125	5		142	143	2139						
	IP67 Std. Pack: 3												



to IEC 60309-2, EN IEC 60309-2, DIN EN IEC 60309-2 (VDE 0623-2). Other voltages and frequencies available on request. Products with pilot contact available on request.

PRODUCT INFORMATION

	A	P	110 V	230 V	400 V	500 V	>50 - 500 V												
			50 a. 60 Hz			50 a. 60 Hz			50 a. 60 Hz			100-300 Hz			300-500 Hz				
			3 p	4 p	5 p	3 p	4 p	5 p	3 p	4 p	5 p	3 p	4 p	5 p	3 p	4 p	5 p		
			4 h	4 h	4 h	6 h	9 h	9 h	9 h	6 h	6 h	7 h	7 h	7 h	10 h	10 h	10 h	2 h	2 h
 <p>Wall mounted receptacle screwless spring terminals, with TwinCONTACT, external fixing</p> <p>IP44 Std. Pack: 10</p>	16	3	1340	1341															
	16	4		1342	1343	1344													
	16	5			31														
	32	3	1345	1346															
	32	4		1347	1348	1349													
	32	5			32														
 <p>Wall mounted receptacle screwless spring terminals, with TwinCONTACT, suitable for through wiring, internal fixing, 4 p and 5 p receptacles the enclosure can be turned 180°</p> <p>IP44 Std. Pack: 10</p>	16	3	1719	1720	1721														
	16	4		1723	1724	1725	1726	1727											
	16	5		1730	3331														
 <p>Wall mounted receptacle screwless spring terminals, with TwinCONTACT, suitable for through wiring, internal fixing, enclosure base can be turned 180°, receptacles are designed for adding an auxiliary contact switch</p> <p>IP44 Std. Pack: 10</p>	16	4	1750	1751	418	1752	1753	1754											
	16	5	1755	1756	419	1757													
	32	3	1851	420	1852														
	32	4		1856	421	1857	1858	1859											
	32	5	1860	1861	422	1862		1864											



to IEC 60309-2, EN IEC 60309-2, DIN EN IEC 60309-2 (VDE 0623-2). Highly resistant to chemicals. Other voltages and frequencies available on request.
Products with pilot contact available on request.

PRODUCT INFORMATION

	A	P	110 V			230 V			400 V			500 V			>50 - 500 V					
			50 a. 60 Hz			50 a. 60 Hz			50 a. 60 Hz			50 a. 60 Hz			100-300 Hz		300-500 Hz			
			3 p	4 p	5 p	3 p	4 p	5 p	3 p	4 p	5 p	3 p	4 p	5 p	3 p	4 p	5 p	3 p	4 p	5 p
 <p>Wall mounted receptacle screwless spring terminals, with TwinCONTACT, highly resistant to chemicals, suitable for through wiring, with 2 external fixing points, receptacles are designed for adding an auxiliary contact switch, enclosure base can be turned 180°</p> <p>IP67 Std. Pack: 10</p>	16	3	9104	9105	9106															
	16	4	9120	9121	9122	9123	9124													
	16	5	9140	9141	9142															
	32	3	9150	9151	9152															
	32	4	9170	9171	9172	9173														
	32	5		9181	9182															
 <p>Double Box screwless spring terminals, with TwinCONTACT, CEE and receptacle SCHUKO® in one enclosure, also available with shock-proof receptacles to comply with French/Belgian and Swiss standards</p> <p>IP44 Std. Pack: 5</p>	16	4		1647	1648															
	16	5			1649															
 <p>Double Box screwless spring terminals, with TwinCONTACT, CEE and receptacle SCHUKO® in one enclosure, with fuse holder, max. 10 A</p> <p>IP44 Std. Pack: 5</p>	16	5			1650															
	32	5			1651															



to IEC 60309-2, EN IEC 60309-2, DIN EN IEC 60309-2 (VDE 0623-2). Other voltages and frequencies available on request.

PRODUCT INFORMATION

	A	P	110 V	230 V	400 V	500 V	>50 - 500 V												
			50 a. 60 Hz			50 a. 60 Hz			50 a. 60 Hz			100-300 Hz			300-500 Hz				
			3 p	4 p	5 p	3 p	4 p	5 p	3 p	4 p	5 p	3 p	4 p	5 p	3 p	4 p	5 p		
			4 h	4 h	4 h	6 h	9 h	9 h	9 h	6 h	6 h	7 h	7 h	7 h	10 h	10 h	10 h	2 h	2 h
 <p>Wall mounted receptacle 63 A: X-CONTACT, with DIN rail, optional fitting of Neozed, Diazed, circuit-breakers and RCD's</p> <p>IP44 Std. Pack: 1</p>	16	3		7007															
	16	4			5496														
	16	5			5495														
	32	5			5497														
	63	4			7153														
	63	5			7102														
 <p>Wall mounted receptacle with circuit breaker, K-characteristics</p> <p>IP44 Std. Pack: 1</p>	16	3		7119															
	16	5			5012														
	32	4			5014														
	32	5			5016														
 <p>Wall mounted receptacle fused with RCD (0.03 A)</p> <p>IP44 Std. Pack: 1</p>	16	3		7125															
	16	4			7126														
	16	5			7312														
	32	4			7127														
	32	5			7313														



to IEC 60309-2, EN IEC 60309-2, DIN EN IEC 60309-2 (VDE 0623-2), DUO-Interlock to IEC 60309-4, EN IEC 60309-4, DIN EN IEC 60309-4 (VDE 0623-3).
Other voltages and frequencies available on request.

PRODUCT INFORMATION

		A	P	110 V	230 V	400 V	500 V	>50 - 500 V					
				50 a. 60 Hz	50 a. 60 Hz	50 a. 60 Hz	50 a. 60 Hz	100-300 Hz		300-500 Hz			
				3 p 4 p 5 p	3 p 4 p 5 p	3 p 4 p 5 p	3 p 4 p 5 p	3 p 4 p 5 p	3 p 4 p 5 p	3 p 4 p 5 p	3 p 4 p 5 p	3 p 4 p 5 p	3 p 4 p 5 p
				4 h 4 h 4 h	6 h 9 h 9 h	9 h 6 h 6 h	7 h 7 h 7 h	10 h 10 h 10 h	2 h 2 h 2 h	2 h 2 h 2 h	2 h 2 h 2 h	2 h 2 h 2 h	2 h 2 h 2 h
 <p>Wall mounted receptacle with DIN rail, optional fitting of Neozed, Diazed, circuit-breakers and RCD's</p>	IP67 Std. Pack: 1	16	3		7128								
		16	4			7129							
		16	5			7130							
		32	5			7132							
 <p>Wall mounted receptacle fused with circuit breaker, K-characteristics</p>	IP67 Std. Pack: 1	16	3		7143								
		16	5			7145							
		32	4			7146							
		32	5			7147							
 <p>Wall mounted receptacle DUO LED voltage indicator, pre-wired for installation, X-CONTACT, switched, mechanical DUO-interlock, 3 pole switch, receptacles can be padlocked</p>	IP44 Std. Pack: 1	16	3	5611304G	5611306G								
		16	4		5611409G	5611406G							
		16	5			5611506G							
		32	3	5613304G	5613306G								
		32	4	5613404G	5613409G	5613406G							
		32	5		5613509G	5613506G							

DUO-Interlock to IEC 60309-4, EN IEC 60309-4, DIN EN IEC 60309-4 (VDE 0623-3).
Other voltages and frequencies available on request.

PRODUCT INFORMATION

		A	P	110 V	230 V	400 V	500 V	>50 - 500 V					
				50 a. 60 Hz	50 a. 60 Hz	50 a. 60 Hz	50 a. 60 Hz	100-300 Hz		300-500 Hz			
				3 p 4 p 5 p	3 p 4 p 5 p	3 p 4 p 5 p	3 p 4 p 5 p	3 p 4 p 5 p	3 p 4 p 5 p	3 p 4 p 5 p	3 p 4 p 5 p	3 p 4 p 5 p	3 p 4 p 5 p
				4 h 4 h 4 h	6 h 9 h 9 h	9 h 6 h 6 h	7 h 7 h 7 h	10 h 10 h 10 h	2 h 2 h 2 h	2 h 2 h 2 h	2 h 2 h 2 h	2 h 2 h 2 h	2 h 2 h 2 h
 <p>Wall mounted receptacle X-CONTACT, switched, with mechanical DUO-interlock, receptacles can be padlocked</p> <p>IP44 Std. Pack: 1</p>	63	3			6571								
	63	4			5955A	5956A	5957A						
	63	5				5959A							
 <p>Wall mounted receptacle switched, with mechanical DUO-interlock, receptacles can be padlocked</p> <p>IP67 Std. Pack: 1</p>	16	3	7602	7603									
	16	4				7605							
	16	5				7607							
	32	3			7612								
	32	4			7613	7614							
	32	5				7616							
 <p>Wall mounted receptacle DUOi LED voltage indicator, pre-wired for installation, X-CONTACT, switched, mechanical DUO-interlock, sealed against dust, temporary submersion and high-pressure cleaning, 3 pole switch, receptacles can be padlocked</p> <p>IP67 / IP69 Std. Pack: 1</p>	16	3	5612304G	5612306G									
	16	4		5612409G	5612406G								
	16	5		5612509G	5612506G								
	32	3	5614304G	5614306G									
	32	4		5614409G	5614406G								
	32	5		5614509G	5614506G								

DUO-Interlock to IEC 60309-4, EN IEC 60309-4, DIN EN IEC 60309-4 (VDE 0623-3).



Highly resistant to chemicals. Other voltages and frequencies available on request.

PRODUCT INFORMATION

		A	P	110 V 50 a. 60 Hz	230 V 50 a. 60 Hz	400 V 50 a. 60 Hz	500 V 50 a. 60 Hz	>50 - 500 V	
				3 p 4 p 5 p 4 h 4 h 4 h	3 p 4 p 5 p 6 h 9 h 9 h	3 p 4 p 5 p 9 h 6 h 6 h	3 p 4 p 5 p 7 h 7 h 7 h	100-300 Hz 3 p 4 p 5 p 10 h 10 h 10 h	300-500 Hz 3 p 4 p 5 p 2 h 2 h 2 h
	Wall mounted receptacle X-CONTACT, switched, with mechanical DUO-interlock, receptacles can be padlocked	63	3	5925A	5911A				
		63	4		5109A	5110A	5111A		
		63	5		5112A	5113A	5759A		
	Wall mounted receptacle DUOi R LED voltage indicator, pre-wired for installation, X-CONTACT, highly resistant to chemicals, highly heat resistant contact carrier, nickel plated contacts, mechanical DUO-interlock, sealed against dust, temporary submersion and high-pressure cleaning IP67 / IP69 Std. Pack: 1	16	3		5812306T				
		16	4			5812406T			
		16	5			5812506T			
		32	3			5814306T			
		32	4				5814406T		
		32	5				5814506T		
	Wall mounted receptacle X-CONTACT, highly resistant to chemicals, highly heat resistant contact carrier, nickel plated contacts, switched, with mechanical DUO-interlock, receptacles can be padlocked	63	4			7289			
		63	5			7290			

DUO-Interlock to IEC 60309-4, EN IEC 60309-4, DIN EN IEC 60309-4 (VDE 0623-3).
Other voltages and frequencies available on request.





PRODUCT INFORMATION

	A	P	110 V	230 V	400 V	500 V	>50 - 500 V						
			50 a. 60 Hz	50 a. 60 Hz	50 a. 60 Hz	50 a. 60 Hz	100-300 Hz			300-500 Hz			
			3 p 4 p 5 p	3 p 4 p 5 p	3 p 4 p 5 p	3 p 4 p 5 p	3 p 4 p 5 p	3 p 4 p 5 p	3 p 4 p 5 p				
			4 h 4 h 4 h	6 h 9 h 9 h	9 h 6 h 6 h	7 h 7 h 7 h	10 h 10 h 10 h	2 h 2 h 2 h					
 <p>Wall mounted receptacle X-CONTACT, switched, with mechanical DUO-interlock</p> <p>IP67 Std. Pack: 1</p>	125	3		7000									
	125	4		5887A	5691A	5690A							
	125	5		5888A	5692A								
 <p>Wall mounted receptacle switched, with mechanical DUO-interlock, receptacles can be padlocked</p> <p>IP67 Std. Pack: 1</p>	16	3	7620	7621									
	16	4		7623	7624								
	16	5			7626								
	32	3		7629									
	32	4			7634								
	32	5			7636								
 <p>Wall mounted receptacle 63 A: X-CONTACT, switched, with mechanical DUO-interlock, DIN rail, receptacles can be padlocked</p> <p>IP44 Std. Pack: 2/1</p>	16	3		7213									
	16	5			5613A								
	32	4			5615A								
	32	5			5618A								
	63	4			6059A								
	63	5			6062A								

DUO-Interlock to IEC 60309-4, EN IEC 60309-4, DIN EN IEC 60309-4 (VDE 0623-3).



Highly resistant to chemicals. Other voltages and frequencies available on request.

PRODUCT INFORMATION



	A	P	110 V	230 V	400 V	500 V	>50 - 500 V													
			50 a. 60 Hz			50 a. 60 Hz			50 a. 60 Hz			100-300 Hz			300-500 Hz					
			3 p	4 p	5 p	3 p	4 p	5 p	3 p	4 p	5 p	3 p	4 p	5 p	3 p	4 p	5 p			
			4 h	4 h	4 h	6 h	9 h	9 h	9 h	6 h	6 h	7 h	7 h	7 h	10 h	10 h	10 h	2 h	2 h	2 h
 <p>Wall mounted receptacle 63 A: X-CONTACT, switched, with mechanical DUO-interlock, circuit breaker, K-characteristics, receptacles can be padlocked</p> <p>IP44 Std. Pack: 2/1</p>	16	5			7218															
	32	4			7219															
	32	5			7220															
	63	4			7221															
	63	5			7222															
 <p>Wall mounted receptacle 63 A: X-CONTACT, switched, with mechanical DUO-interlock, DIN rail, receptacles can be padlocked</p> <p>IP67 Std. Pack: 1</p>	16	3		7050																
	16	4			5630A															
	16	5			5633A															
	32	4			5635A															
	32	5			5638A															
	63	4			5640A		5641A													
 <p>Wall mounted receptacle 63 A: X-CONTACT, highly resistant to chemicals, highly heat resistant contact carrier, nickel plated contacts, switched, with mechanical DUO-interlock, DIN-rail, receptacles can be padlocked</p> <p>IP67 Std. Pack: 1</p> 	16	5			7292															
	32	5			7294															
	63	5			7296															

DUO-Interlock to IEC 60309-4, EN IEC 60309-4, DIN EN IEC 60309-4 (VDE 0623-3). Other voltages and frequencies available on request.

PRODUCT INFORMATION

	A	P	110 V	230 V	400 V	500 V	>50 - 500 V											
			50 a. 60 Hz			50 a. 60 Hz			50 a. 60 Hz			100-300 Hz		300-500 Hz				
			3 p	4 p	5 p	3 p	4 p	5 p	3 p	4 p	5 p	3 p	4 p	5 p	3 p	4 p	5 p	
			4 h	4 h	4 h	6 h	9 h	9 h	9 h	6 h	6 h	7 h	7 h	7 h	10 h	10 h	10 h	2 h
 <p>Wall mounted receptacle 63 A: X-CONTACT, switched, with mechanical DUO-interlock, circuit breaker, K-characteristics, receptacles can be padlocked</p> <p>IP67 Std. Pack: 2/1</p>	16	3		7238														
	32	4			7241													
	32	5			7242													
	63	4			7243													
	63	5			7244													
 <p>Wall mounted receptacle 63 A: X-CONTACT, switched, with mechanical DUO-interlock, RCD 0.03 A, receptacles can be padlocked</p> <p>IP67 Std. Pack: 1</p>	16	3		7245														
	16	4			7246													
	16	5			7247													
	32	4			7248													
	32	5			7249													
	63	4			7250													
 <p>Wall mounted receptacle X-CONTACT, switched, with mechanical DUO-interlock, 3 pole fuse socket NH 00</p> <p>IP67 Std. Pack: 1</p>	125	4			5679A	5693A												
	125	5			5695A													

to IEC 60309-2, EN IEC 60309-2, DIN EN IEC 60309-2 (VDE 0623-2). Other voltages and frequencies available on request.

		A	P	110 V	230 V	400 V	500 V	>50 - 500 V					
				50 a. 60 Hz	50 a. 60 Hz	50 a. 60 Hz	50 a. 60 Hz	100-300 Hz			300-500 Hz		
				3 p 4 p 5 p	3 p 4 p 5 p	3 p 4 p 5 p	3 p 4 p 5 p	3 p 4 p 5 p	3 p 4 p 5 p	3 p 4 p 5 p	3 p 4 p 5 p	3 p 4 p 5 p	3 p 4 p 5 p
				4 h 4 h 4 h	6 h 9 h 9 h	9 h 6 h 6 h	7 h 7 h 7 h	10 h 10 h 10 h	2 h 2 h 2 h	2 h 2 h 2 h	2 h 2 h 2 h	2 h 2 h 2 h	2 h 2 h 2 h
 <p>Wall mounted receptacle Cepex light grey</p> <p>IP44 Std. Pack: 5</p>	16	3	4101	4102									
	16	4		4254	4103								
	16	5			4105								
	32	3	4107										
	32	4			4108								
	32	5			4110								
 <p>Wall mounted receptacle Cepex light grey, with labelling field</p> <p>IP44 Std. Pack: 5</p>	16	3		4132									
	16	4			4133								
	16	5			4135								
	32	3	4137										
	32	5			4140								
 <p>Wall mounted receptacle Cepex pearl white</p> <p>IP44 Std. Pack: 5</p>	16	3		4112									
	16	4		4233	4113								
	16	5			4115								
	32	3	4117										
	32	4			4118	4119							
	32	5			4120								

to IEC 60309-2, EN IEC 60309-2, DIN EN IEC 60309-2 (VDE 0623-2). Other voltages and frequencies available on request.

	A	P	110 V	230 V	400 V	500 V	>50 - 500 V												
			50 a. 60 Hz			50 a. 60 Hz			50 a. 60 Hz			100-300 Hz			300-500 Hz				
			3 p	4 p	5 p	3 p	4 p	5 p	3 p	4 p	5 p	3 p	4 p	5 p	3 p	4 p	5 p		
			4 h	4 h	4 h	6 h	9 h	9 h	9 h	6 h	6 h	7 h	7 h	7 h	10 h	10 h	10 h	2 h	2 h
 <p>Flush mounted receptacle Cepex pearl white, with flush mounted installation box</p> <p>IP44 Std. Pack: 5</p>	16	3		4122															
	16	4			4123														
	16	5			4125														
	32	3		4127															
	32	4			4128														
	32	5			4130														
 <p>Wall mounted Cepex double receptacle light grey</p> <p>IP44 Std. Pack: 5/4</p>	16	3		4219															
	16	5			4204														



N.B.: All above mentioned types are available in three designs and with SCHUKO® insert:

- with smooth cover
- with labelling field
- with labelling field and lockable cover

Also available with data port inserts.
Distance frame on request.
Cepex range panel receptacles rated 16 A and 32 A have the same dimensions.
It is, therefore, possible to interchange single or 3 phase receptacles on a 2-gang enclosure to suit your own requirements.



to IEC 60309-2, EN IEC 60309-2, DIN EN IEC 60309-2 (VDE 0623-2). Other voltages and frequencies available on request. Products with pilot contact available on request.

PRODUCT INFORMATION

	A	P	110 V	230 V	400 V	500 V	>50 - 500 V											
			50 a, 60 Hz			50 a, 60 Hz			50 a, 60 Hz			100-300 Hz			300-500 Hz			
			3 p	4 p	5 p	3 p	4 p	5 p	3 p	4 p	5 p	3 p	4 p	5 p	3 p	4 p	5 p	
 <p>Panel mounted receptacle straight</p> <p>IP44 Std. Pack: 10</p>	16	3	1365	1366	1367												3055	
	16	4	1388	1389	1390	1391	1392	1393										
	16	5	1384	1386	1385	3057	3059	3060										
	32	3	1394	1395	1396													
	32	4	1397	1398	1399	1400	1401											
	32	5		3454	3451	3452												3447
 <p>Panel mounted receptacle X-CONTACT, straight</p> <p>IP44 Std. Pack: 5</p>	63	3	1260A	1261A														
	63	4		1247A	1248A	1249A												
	63	5			1252A													
 <p>Panel mounted receptacle flange 16 A, 3 p: 73.5 x 64 mm, 16 A, 4 + 5 p, 32 A: 100 x 92 mm, inclination 20°, 32 A: receptacles optional fitted with auxiliary contact</p> <p>IP44 Std. Pack: 10</p>	16	3	1462	1463	1464		3186	3187										
	16	4		1466	1467	1468	1469											
	16	5	1471	1472	1473	3188	3189	3190										
	32	3	1491	1492	1493													3202
	32	4	1494	1495	1496	1497	1486											
	32	5		1499	1500	3191	3192	3193										



to IEC 60309-2, EN IEC 60309-2, DIN EN IEC 60309-2 (VDE 0623-2). Other voltages and frequencies available on request. Products with pilot contact available on request.

PRODUCT INFORMATION

		A	P	110 V	230 V	400 V	500 V	>50 - 500 V					
				50 a. 60 Hz	50 a. 60 Hz	50 a. 60 Hz	50 a. 60 Hz	100-300 Hz		300-500 Hz			
				3 p 4 p 5 p	3 p 4 p 5 p	3 p 4 p 5 p	3 p 4 p 5 p	3 p 4 p 5 p	3 p 4 p 5 p	3 p 4 p 5 p	3 p 4 p 5 p	3 p 4 p 5 p	3 p 4 p 5 p
				4 h 4 h 4 h	6 h 9 h 9 h	9 h 6 h 6 h	7 h 7 h 7 h	10 h 10 h 10 h	2 h 2 h 2 h	2 h 2 h 2 h	2 h 2 h 2 h	2 h 2 h 2 h	2 h 2 h 2 h
 <p>Panel mounted receptacle X-CONTACT, highly heat resistant contact carrier, 20° inclination</p> <p>IP44 Std. Pack: 5</p>	63	3			1147A								
	63	4			1150A	1151A	1152A						
	63	5			1154A	1155A							
 <p>Panel mounted receptacle 63 A: X-CONTACT, standard flange dimensions, uniform fixing hole spacing, 15° inclination for 16 A and 32 A, 20° inclination for 63 A</p> <p>IP44 Std. Pack: 5</p>	16	5				20146A							
	32	5				20147A							
	63	5				21160A							
 <p>Panel mounted receptacle small flange dimensions, inclination 20°</p> <p>IP44 Std. Pack: 10</p>	16	3		858	857								



to IEC 60309-2, EN IEC 60309-2, DIN EN IEC 60309-2 (VDE 0623-2). Other voltages and frequencies available on request. Products with pilot contact available on request.

PRODUCT INFORMATION

	A	P	110 V	230 V	400 V	500 V	>50 - 500 V												
			50 a. 60 Hz			50 a. 60 Hz			50 a. 60 Hz			100-300 Hz		300-500 Hz					
			3 p	4 p	5 p	3 p	4 p	5 p	3 p	4 p	5 p	3 p	4 p	5 p					
			4 h	4 h	4 h	6 h	9 h	9 h	9 h	6 h	6 h	7 h	7 h	7 h	10 h	10 h	10 h	2 h	2 h
 <p>Panel mounted receptacle flange 16 A: 75 x 75 mm, 32 A: 85 x 75 mm, straight</p> <p>IP67 Std. Pack: 10</p>	16	3	217A	218A	219A														
	16	4		221A	222A	223A													
	16	5		227A	228A														
	32	3	229A	230A	231A														
	32	4	232A	233A	234A	235A													
	32	5	238A	239A	240A														
 <p>Panel mounted receptacle X-CONTACT, flange 63 A: 107 x 100 mm, 125 A: 130 x 130 mm, straight</p> <p>IP67 Std. Pack: 5</p>	63	3	1263A	1264A	1265A														
	63	4		1123A	1124A	1125A													
	63	5		1127A	1128A														
	125	3		3380															
	125	4	1455	1456	1457	1458													
	125	5		1460	1461	3283													
 <p>Panel mounted receptacle flange 16 A, 3 p: 73.5 x 64 mm, 16 A, 4 + 5 p, 32 A: 100 x 92 mm, inclination 20°, 32 A receptacles optional fitted with auxiliary contact</p> <p>IP67 Std. Pack: 10</p>	16	3	1474	1475	1476														
	16	4	1477	1478	1479	1480													
	16	5		1484	1485														
	32	3	1501	1502	1503														
	32	4	1504	1505	1506	1507													
	32	5		1490	1551														

to IEC 60309-2, EN IEC 60309-2, DIN EN IEC 60309-2 (VDE 0623-2). Other voltages and frequencies available on request. Products with pilot contact available on request.

PRODUCT INFORMATION

	A	P	110 V	230 V	400 V	500 V	>50 - 500 V										
			50 a. 60 Hz			50 a. 60 Hz			50 a. 60 Hz			100-300 Hz			300-500 Hz		
			3 p	4 p	5 p	3 p	4 p	5 p	3 p	4 p	5 p	3 p	4 p	5 p	3 p	4 p	5 p
	63	3	2179A	2180A	2181A												
	63	4		204A	205A	206A											
	63	5		208A	209A	3507											
	125	3		3575													
	125	4		211A	212A	213A											
	125	5		215A	216A												
	16	3	903	905													
	16	4			1081												
	16	5			1103												
	32	3	3197	3200													
	32	4			3254	3256											
	32	5			3524												
																	
	Part no.																
	41000																

Panel mounted receptacle
X-CONTACT, flange 63 A: 110 x 106 mm, inclination 20°, 125 A: 114 x 110 mm, inclination 15°

IP67
Std. Pack: 5

Panel mounted receptacle
standard flange dimensions, inclination 20°, optional fitted with auxiliary contact



IP67
Std. Pack: 10

Auxiliary contact
for standard receptacles and panel mounted receptacles 16 A and 32 A

Std. Pack:10



to IEC 60309-2, EN IEC 60309-2, DIN EN IEC 60309-2 (VDE 0623-2). Other voltages and frequencies available on request.

PRODUCT INFORMATION

	A	P	110 V	230 V	400 V	500 V	>50 - 500 V												
			50 a. 60 Hz			50 a. 60 Hz			50 a. 60 Hz			100-300 Hz			300-500 Hz				
			3 p	4 p	5 p	3 p	4 p	5 p	3 p	4 p	5 p	3 p	4 p	5 p	3 p	4 p	5 p		
			4 h	4 h	4 h	6 h	9 h	9 h	9 h	6 h	6 h	7 h	7 h	7 h	10 h	10 h	10 h	2 h	2 h
 <p>Panel mounted receptacle screwless spring terminals, with TwinCONTACT, suitable for through wiring, straight</p> <p>IP44 Std. Pack: 10</p>	16	3	1667	1668	1669													1671	
	16	4	1672	1673	1674	1675		1676											1677
	16	5	1678	1679	3385	1680													1682
	32	3	1786	1787	1788														
	32	4		1790	1791	1792		1793											
	32	5	1795	1796	1797	1798													1800
 <p>Panel mounted receptacle screwless spring terminals, with TwinCONTACT, inclination 20°, 32 A: optional fitted with auxiliary contact</p> <p>IP44 Std. Pack: 10</p>	16	3	1631	1632	1633													1635	
	16	4		1637	1638	1639		1640											1641
	16	5	1642	1643	3473	1644													1646
	32	3	1733	1734	1735														
	32	4		1739	1740	1741		1742											1743
	32	5		1745	1746	1747													
 <p>Panel mounted receptacle screwless spring terminals, with TwinCONTACT, standard flange dimensions, 20° inclination, optional fitted with auxiliary contact</p> <p>IP44 Std. Pack:10</p>	16	3		3008															
	16	4			3048	3049													
	16	5			3070														
	32	3		3126															
	32	4			3155	3157													
	32	5			3171														

to IEC 60309-2, EN IEC 60309-2, DIN EN IEC 60309-2 (VDE 0623-2). Other voltages and frequencies available on request.

PRODUCT INFORMATION

		A	P	110 V 50 a. 60 Hz	230 V 50 a. 60 Hz	400 V 50 a. 60 Hz	500 V 50 a. 60 Hz	>50 - 500 V					
				3 p 4 p 5 p 4 h 4 h 4 h	3 p 4 p 5 p 6 h 9 h 9 h	3 p 4 p 5 p 9 h 6 h 6 h	3 p 4 p 5 p 7 h 7 h 7 h	100-300 Hz			300-500 Hz		
				3 p 4 p 5 p	3 p 4 p 5 p	3 p 4 p 5 p	3 p 4 p 5 p	3 p 4 p 5 p	3 p 4 p 5 p	3 p 4 p 5 p	3 p 4 p 5 p	3 p 4 p 5 p	3 p 4 p 5 p
 <p>Panel mounted receptacle screwless spring terminals, with TwinCONTACT, suitable for through wiring, small flange dimensions straight</p> <p>IP44 Std. Pack: 10</p>	16	3	1618	1619									
 <p>Panel mounted receptacle screwless spring terminals, with TwinCONTACT, suitable for through wiring, straight</p> <p>IP67 Std. Pack: 10</p>	16	3	1707	1708	1709								
	16	4	1710	1711	1712	1713	1714						
	16	5	1716	1717	1131								
	32	3	1809	1810									
	32	4		1813	1814	1815	1816						
	32	5			1820								
 <p>Panel mounted receptacle screwless spring terminals, with TwinCONTACT, suitable for through wiring, inclination 20°, 32 A: optionally fitted with auxiliary contact</p> <p>IP67 Std. Pack: 10</p>	16	3	1700	1701	1702								
	16	4		1703	1704								
	16	5			3485								
	32	3		1802	1803								
	32	4		1804	1805	1806							
	32	5			1808								



to IEC 60309-2, EN IEC 60309-2, DIN EN IEC 60309-2 (VDE 0623-2). Other voltages and frequencies available on request.

PRODUCT INFORMATION

	A	P	110 V	230 V	400 V	500 V	>50 - 500 V												
			50 a. 60 Hz			50 a. 60 Hz			50 a. 60 Hz			100-300 Hz			300-500 Hz				
			3 p	4 p	5 p	3 p	4 p	5 p	3 p	4 p	5 p	3 p	4 p	5 p	3 p	4 p	5 p		
			4 h	4 h	4 h	6 h	9 h	9 h	9 h	6 h	6 h	7 h	7 h	7 h	10 h	10 h	10 h	2 h	2 h
																			
Panel mounted receptacle screwless spring terminals, with TwinCONTACT, standard flange dimensions, inclination 20°, optionally fitted with auxiliary contact																			
IP67 Std. Pack: 10																			
	16	3		1168															
	16	4			1169														
	16	5			1173														
	32	3	3566	3573															
	32	4			3581														
	32	5			3590														

DUO-Interlock to IEC 60309-4, EN IEC 60309-4, DIN EN IEC 60309-4 (VDE 0623-3). Other voltages and frequencies available on request.

PRODUCT INFORMATION

		A	P	110 V	230 V	400 V	500 V	>50 - 500 V					
				50 a. 60 Hz	50 a. 60 Hz	50 a. 60 Hz	50 a. 60 Hz	100-300 Hz			300-500 Hz		
				3 p 4 p 5 p	3 p 4 p 5 p	3 p 4 p 5 p	3 p 4 p 5 p	3 p 4 p 5 p	3 p 4 p 5 p	3 p 4 p 5 p	3 p 4 p 5 p	3 p 4 p 5 p	3 p 4 p 5 p
				4 h 4 h 4 h	6 h 9 h 9 h	9 h 6 h 6 h	7 h 7 h 7 h	10 h 10 h 10 h	2 h 2 h 2 h	2 h 2 h 2 h	2 h 2 h 2 h	2 h 2 h 2 h	2 h 2 h 2 h
 <p>Panel mounted receptacle switched, with mechanical DUO-interlock, receptacles can be padlocked</p> <p>IP44 Std. Pack: 1</p>	16	3			7503								
	16	4			7504								
	16	5				7507							
	32	3			7512								
	32	4						7515					
	32	5					7516						
	 <p>Panel mounted receptacle switched, with mechanical DUO-interlock, receptacles can be padlocked</p> <p>IP67 Std. Pack: 1</p>	16	3	7520	7521								
16		4			7524		7525						
16		5				7526							
32		3	7530	7531									
32		4				7534		7535					
32		5					7536						

Our PowerTOP Xtra Family from 16 to 125 A. Plugs and sockets for all applications.

In industrial applications, in mining, in railway and transport companies, in ports, harbors, and shipyards, on campgrounds: in all of these situations and many more, it's imperative to safely and reliably distribute electric power in challenging or harsh conditions. As specialists for plugs and sockets, we've packed our formidable CEE know-how into a top-notch product family for you. The PowerTOP Xtra plugs and connectors are available in 16, 32, 63, and 125 A versions. Many of them have been proving themselves in practice in a wide variety of work environments worldwide for years. All PowerTOP Xtra connectors feature our ingenious X-CONTACT contact sleeve technology.





PowerTOP Xtra: plugs and connectors for professional electricians!



Our PowerTOP Xtra Family from 16 to 125 A. Plugs and sockets for all applications.

PowerTOP Xtra is a complete product family with solutions for every application area. In this regard plugs and connectors in 16 A and 32 A have been completely reworked and optimised in every detail! The members of the PowerTOP Xtra family bring four success factors from professionals for professionals:



-  **Ergonomically optimised design**
-  **Simplified assembly**
-  **Easier and safer connection**
-  **Effortless connecting and disconnecting with X-CONTACT**

Plugs and connectors with IP67 / IP69 protection.

NEW

The waterproof plugs and connectors from our PowerTOP Xtra series, featuring the proven ErgoCONTACT screw connection technology and ergonomic enclosure design, have been expanded with a new feature. In addition to protection against temporary submersion (IP67), they also provide additional protection against water with particularly high pressure and high temperatures (IP69). This makes them suitable for long-term use in environments with frequent high-pressure cleaning.

Thanks to sealing with a screw cap and a bayonet ring, no water can penetrate the plugs and connectors. For use in areas with special environmental conditions, such as the food industry, the plugs and connectors with IP67 / IP69 protection are particularly well-suited. The double protection against temporary submersion and water with high pressure and high temperatures makes them robust and durable.



Even during repeated high-pressure cleaning, our plugs and connectors in IP67 / IP69 remain waterproof, and thanks to textured grip surfaces, they can be operated safely and easily even in moisture and wet conditions. When plugged, the rubberised bayonet ring keeps the plug tightly connected with the connector or receptacle.

X-CONTACT

The new generation of contact sleeves.



Better contact

Due to a completely new manufacturing process, the X-CONTACT sleeve obtains resilient properties based solely on its material characteristics, without the need to use any additional spring elements. Thanks to the design of the X-CONTACT sleeve, a particularly safe contact closure can be achieved.



Less effort

The special design of the X-CONTACT reduces the effort of insertion and withdrawal by up to 50 %. An advantage that simplifies work processes and improves safety especially with high electrical currents. With X-CONTACT, MENNEKES creates a safe contact closure and easy handling at a new, equally high level.

Get more information on the new generation of contact sleeves at: www.MENNEKES.org

The X principle

Easy handling meets safe connections.

Innovative

Due to the slotted sleeves with their resilient material properties, X-CONTACT is the simplest possible mechanical solution: the plug pin simply expands the opening of the resilient contact sleeve, which reduces the force needed to connect and disconnect the plug by up to 50 %.

X-CONTACT – intelligently innovative!

Durable

Even in cases when the plug is connected and disconnected frequently, there are no signs of wear and the sleeve material remains fatigue-proof in the long term even after rough handling. Due to the quality of the new sleeves, contamination and surface corrosion is automatically removed by connecting and disconnecting.

X-CONTACT – lasting solution!

Simple

In practice, X-CONTACT simplifies work processes. The connection can now be handled by one person even with a current of 125 A, while conventional contact sleeves required two persons to connect and disconnect.

X-CONTACT – simply brilliant!

Safe

A higher degree of safety of handling is provided by the easier connection and disconnection. The groove within the inner wall in connection with the resilient material of the contact sleeves provides for a safe contact closure.

X-CONTACT – double safety!



Easier and safer connection with ErgoCONTACT.



All products of the PowerTOP Xtra family are available with screw terminals. We've developed them further to create our easy-to-use ErgoCONTACT connection technology for 16 and 32 A plugs and connectors. They enable easy, secure and time-saving installation.

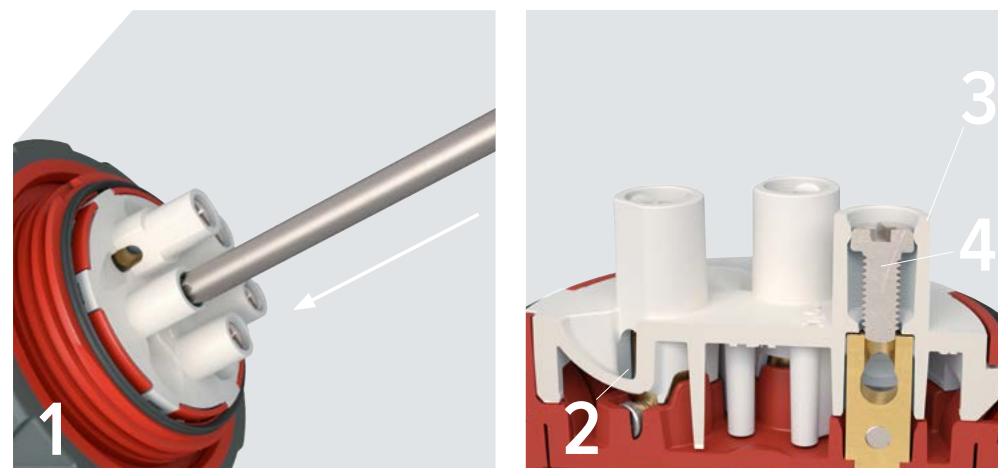

1

Ergonomically effective installation

With ErgoCONTACT, you insert the screwdriver from the top instead of from the side. This makes it easier to achieve the required torque and the pressure is applied directly from the grip. All of the screws point in the same direction. This saves time, because it's no longer necessary to rotate the front part in your hand in order to tighten the contact screws of the individual poles one after the other.

2

Conductor insertion

Curved conductor guidance channels easily and securely move the conductor ends into the contacts.

3

Guide collar

The screw trajectory is additionally supported by a guide collar which prevents slide-off and minimises the danger of injury.

4

Captive combination head screw

Each contact has only one screw: a captive combination head screw that is permanently integrated in the guide collar in the factory and can be turned using either a Phillips or a flathead screwdriver. Since only one screw has to be set for each contact, installation is easy and time-saving.

Easier and safer connection with SafeCONTACT.



Our 16 and 32 A plugs and connectors are also available in PowerTOP Xtra S versions with our proprietary SafeCONTACT screwless connection technology. It eliminates the need to peel the insulation off the wires or otherwise prepare them, letting you make connections more than twice as fast and eliminating subsequent maintenance!



Safer contact

Plug in conductors without stripping, lever down the terminals with a screwdriver – that's it.



Interior view of SafeCONTACT

In one work process the insulation is separated and a secure contact connection established.

PowerTOP Xtra R for use in corrosive environments.

Highly heat resistant contact carrier and nickel plated contacts. These appliances are guaranteed to be resistant to corrosive environments: High humidity, salt or acidic air, corrosive gases and vapours. Accordingly, they are mainly used in the food processing industry, in breweries, dairies, farms and market gardens, wineries.

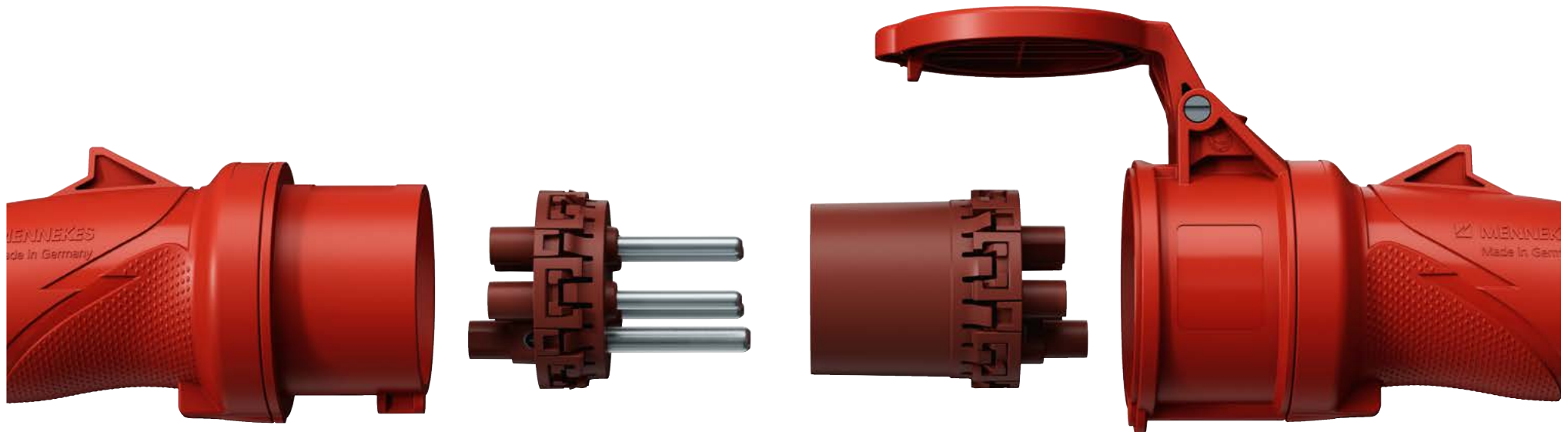

ProTOP

Convenient and reliable.

Many handy features, e.g., the self-locating thread for tight and stable connection of cover and front part. Cable gland with internal strain relief.

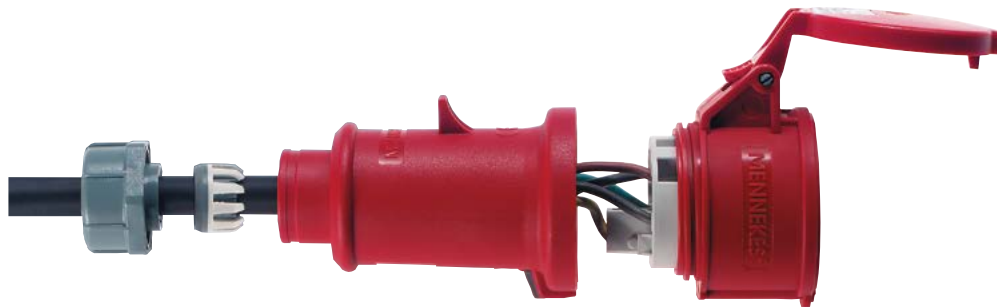

Angled plug VarioTOP



Ergonomic. Practical. Safe.

The first CEE angled plug with cable entry rotating up to 60° to the left or to the right.





to IEC 60309-2, EN IEC 60309-2, DIN EN IEC 60309-2 (VDE 0623-2). Other voltages and frequencies available on request.

PRODUCT INFORMATION

	A	P	110 V	230 V	400 V	500 V	>50 - 500 V												
			50 a. 60 Hz			50 a. 60 Hz			50 a. 60 Hz			100-300 Hz		300-500 Hz					
			3 p	4 p	5 p	3 p	4 p	5 p	3 p	4 p	5 p	3 p	4 p	5 p	3 p	4 p	5 p		
			4 h	4 h	4 h	6 h	9 h	9 h	9 h	6 h	6 h	7 h	7 h	7 h	10 h	10 h	10 h	2 h	2 h
 <p>Plug PowerTOP Xtra S with SafeCONTACT screwless, with insulation displacement technology, ergonomic enclosure design with nubbed grip zones, rubberised cable gland with sealing, strain relief and protection against kinking</p> <p>IP54 Std. Pack: 10</p>	16	3		13521															
	16	5			13522														
	32	5			13523														
 <p>Plug PowerTOP Xtra with ErgoCONTACT screw connection technology ErgoCONTACT, ergonomic enclosure design with nubbed grip zones, rubberised cable gland with sealing, strain relief and protection against kinking</p> <p>IP54 Std. Pack: 10</p>	16	3	13501*	13502	13503*														
	16	4	13504*	13505*	13506	13507*	13508*												
	16	5		13509	13510	13511													
	32	3	13512*	13513	13514*														
	32	4		13515*	13516	13517*	13518*												
	32	5		13519	13520														
* Available from 01.06.2024																			
 <p>Plug PowerTOP Xtra R with ErgoCONTACT screw connection technology ErgoCONTACT, highly heat resistant contact carrier, nickel plated contacts, ergonomic enclosure design with nubbed grip zones, rubberised cable gland with sealing</p> <p>IP54 Std. Pack: 10</p>	16	3	13550*	13551*	13552*	13553*	13554*	13555*											
	16	4	13556*	13557*	13558*	13559*													
	16	5	13561	13562	13563	13564	13565	13566											
	32	3	13572*	13573*	13574*														
	32	4	13577*	13578*	13579*	13580*													
	32	5	13582	13583	13584	13585	13586	13587											
* Available from 01.06.2024																			

to IEC 60309-2, EN IEC 60309-2, DIN EN IEC 60309-2 (VDE 0623-2). Other voltages and frequencies available on request.

PRODUCT INFORMATION

	A	P	110 V	230 V	400 V	500 V	>50 - 500 V											
			50 a. 60 Hz			50 a. 60 Hz			50 a. 60 Hz			100-300 Hz		300-500 Hz				
			3 p	4 p	5 p	3 p	4 p	5 p	3 p	4 p	5 p	3 p	4 p	5 p	3 p	4 p	5 p	
			4 h	4 h	4 h	6 h	9 h	9 h	9 h	6 h	6 h	7 h	7 h	7 h	10 h	10 h	10 h	2 h
 <p>Plug PowerTOP Xtra with ErgoCONTACT screw connection technology ErgoCONTACT, ergonomic enclosure design with nubbed grip zones, rubberised bayonet ring, sealed against dust, temporary submersion and high-pressure cleaning IP67 / IP69 Std. Pack: 10</p>	16	3	13619*	13620*														
	16	4		13621**	13622**	13623**												
	16	5			13624*													
	32	3			13625**													
	32	4			13626**	13627**	13628**											
	32	5				13629*												
						* Available from 01.08.2024			** Available from 01.11.2024									
 <p>Plug PowerTOP Xtra R with ErgoCONTACT screw connection technology ErgoCONTACT, ergonomic enclosure design with nubbed grip zones, highly heat resistant contact carrier, nickel plated contacts, rubberised bayonet ring, sealed against dust, temporary submersion and high-pressure cleaning IP67 / IP69 - Std. Pack: 10</p>	16	3	13630*	13631*	13632*	13633*	13634*											
	16	4	13635**	13636**	13637**	13638**	13639**	13640**										
	16	5	13641*	13642*	13643*	13644*	13645*											
	32	3	13649**	13650**	13651**													
	32	4	13652**	13653**	13654**	13655**	13656**	13657**										
	32	5	13658*	13659*	13660*	13661*												
						* Available from 01.08.2024			** Available from 01.11.2024									
 <p>Plug PowerTOP Xtra rubberised grip area, highly heat resistant contact carrier, frame terminals, nickel plated contacts, cable gland and sealing, strain relief and protection against kinking, enclosure with thread lock, two safety slides IP54 Std. Pack: 5</p>	63	3	13101	13102														
	63	4		13105	13106	13107												
	63	5		13111	13112													



to IEC 60309-2, EN IEC 60309-2, DIN EN IEC 60309-2 (VDE 0623-2). Other voltages and frequencies available on request.

PRODUCT INFORMATION

	A	P	110 V	230 V	400 V	500 V	>50 - 500 V												
			50 a. 60 Hz	50 a. 60 Hz	50 a. 60 Hz	50 a. 60 Hz	100-300 Hz			300-500 Hz									
			3 p 4 p 5 p	3 p 4 p 5 p	3 p 4 p 5 p	3 p 4 p 5 p	3 p 4 p 5 p	3 p 4 p 5 p	3 p 4 p 5 p	3 p 4 p 5 p									
			4 h 4 h 4 h	6 h 9 h 9 h	9 h 6 h 6 h	7 h 7 h 7 h	10 h 10 h 10 h	2 h 2 h 2 h	2 h 2 h 2 h										
																			
Plug PowerTOP Xtra																			
rubberised grip area, highly heat resistant contact carrier, frame terminals, nickel plated contacts, cable gland and sealing, strain relief and protection against kinking, thread lock, two safety slides																			
IP67																			
Std. Pack: 5																			
	63	3	13201	13202	13203														
	63	4	13204	13205	13206	13207	13208	13209											
	63	5	13210	13211	13212	13213		13214											
	125	3	13215	13216															
	125	4	13217	13218	13219	13220													
	125	5	13223	13224	13225	13226		13227											

to IEC 60309-2, EN IEC 60309-2, DIN EN IEC 60309-2 (VDE 0623-2). Other voltages and frequencies available on request.

PRODUCT INFORMATION

		A	P	110 V	230 V	400 V	500 V	>50 - 500 V					
				50 a. 60 Hz	50 a. 60 Hz	50 a. 60 Hz	50 a. 60 Hz	100-300 Hz		300-500 Hz			
				3 p 4 p 5 p	3 p 4 p 5 p	3 p 4 p 5 p	3 p 4 p 5 p	3 p 4 p 5 p	3 p 4 p 5 p	3 p 4 p 5 p	3 p 4 p 5 p	3 p 4 p 5 p	3 p 4 p 5 p
				4 h 4 h 4 h	6 h 9 h 9 h	9 h 6 h 6 h	7 h 7 h 7 h	10 h 10 h 10 h	2 h 2 h 2 h	2 h 2 h 2 h	2 h 2 h 2 h	2 h 2 h 2 h	2 h 2 h 2 h
 <p>Angled plug VariotOP nickel plated contacts, with grommet, cable entry hood rotating up to 60° to the left or the right 3980: in colour code 3983 and 3982: in light grey</p> <p>IP44 Std. Pack: 10</p>	16	5				3980							
	16	5			3983	3982							
 <p>Angled plug with grommet, nickel plated contacts</p> <p>IP44 Std. Pack: 10</p>	16	3	1410	1411									
	16	4			891	315							
 <p>Angled plug with grommet, nickel plated contacts</p> <p>IP44 Std. Pack:10</p>	16	4			891	315							
	16	4											



to IEC 60309-2, EN IEC 60309-2, DIN EN IEC 60309-2 (VDE 0623-2). Other voltages and frequencies available on request.

PRODUCT INFORMATION

	A	P	110 V	230 V	400 V	500 V	>50 - 500 V						
			50 a, 60 Hz	50 a, 60 Hz	50 a, 60 Hz	50 a, 60 Hz	100-300 Hz			300-500 Hz			
			3 p 4 p 5 p	3 p 4 p 5 p	3 p 4 p 5 p	3 p 4 p 5 p	3 p 4 p 5 p	3 p 4 p 5 p	3 p 4 p 5 p	3 p 4 p 5 p			
			4 h 4 h 4 h	6 h 9 h 9 h	9 h 6 h 6 h	7 h 7 h 7 h	10 h 10 h 10 h	2 h 2 h 2 h	2 h 2 h 2 h				
 <p>Angled plug with grommet, nickel plated contacts</p> <p>IP44 Std. Pack: 10</p>	32	3		3306									
	32	4		3646	3987								
	32	5		3424	3266								



to IEC 60309-2, EN IEC 60309-2, DIN EN IEC 60309-2 (VDE 0623-2). Other voltages and frequencies available on request.

PRODUCT INFORMATION

	A	P	110 V	230 V	400 V	500 V	>50 - 500 V											
			50 a, 60 Hz			50 a, 60 Hz			50 a, 60 Hz			50 a, 60 Hz			100-300 Hz		300-500 Hz	
			3 p	4 p	5 p	3 p	4 p	5 p	3 p	4 p	5 p	3 p	4 p	5 p	3 p	4 p	5 p	
			4 h	4 h	4 h	6 h	9 h	9 h	9 h	6 h	6 h	7 h	7 h	7 h	10 h	10 h	10 h	2 h
 <p>Wall mounted inlet for internal or external fixing, for hinged lids for retrofit see part no. 41482 and 41489</p> <p>IP44 Std. Pack: 10</p>	16	3	843	844														
 <p>Wall mounted inlet with hinged lid, for internal or external fixing</p> <p>IP44 Std. Pack: 10</p>	16	3	846	847														
 <p>Wall mounted inlet for external fixing</p> <p>IP44 Std. Pack:10</p>	16	4			800													
	16	5			801													
	32	3		802														
	32	4			803													
	32	5			804													



to IEC 60309-2, EN IEC 60309-2, DIN EN IEC 60309-2 (VDE 0623-2). Other voltages and frequencies available on request.

PRODUCT INFORMATION

	A	P	110 V	230 V	400 V	500 V	>50 - 500 V											
			50 a. 60 Hz			50 a. 60 Hz			50 a. 60 Hz			100-300 Hz			300-500 Hz			
			3 p	4 p	5 p	3 p	4 p	5 p	3 p	4 p	5 p	3 p	4 p	5 p	3 p	4 p	5 p	
			4 h	4 h	4 h	6 h	9 h	9 h	9 h	6 h	6 h	7 h	7 h	7 h	10 h	10 h	10 h	2 h
 <p>Wall mounted inlet enclosure base with stamped recess for quick cutting out, cable entry also possible on the back side</p> <p>IP44 Std. Pack: 10</p>	16	3	331	332	333													
	16	4	334	335	336	337	921											
	16	5	340	341	342	2359	2668	2400										
	32	3	343	344	345													
	32	4		347	348	349												
	32	5	352	353	354	2386												
 <p>Wall mounted inlet for a suitable watertight protective cover for 63 A see part no. 40434</p> <p>IP67 Std. Pack: 5/3</p>	63	3		1107	1217													
	63	4		356	357	358												
	63	5		360	361													
	125	4		363	364	365												
	125	5		367	368													
 <p>Hinged lid for retrofitting for wall mounted inlets</p> <p>Std. Pack:10</p>	Description					Part no.												
	for part no. 843 and 844					41482												
	for part no. 800, 801 and 3517					41489												



to IEC 60309-2, EN IEC 60309-2, DIN EN IEC 60309-2 (VDE 0623-2). Other voltages and frequencies available on request.

PRODUCT INFORMATION

		A	P	110 V	230 V	400 V	500 V	>50 - 500 V					
				50 a. 60 Hz	50 a. 60 Hz	50 a. 60 Hz	50 a. 60 Hz	100-300 Hz			300-500 Hz		
				3 p 4 p 5 p	3 p 4 p 5 p	3 p 4 p 5 p	3 p 4 p 5 p	3 p 4 p 5 p	3 p 4 p 5 p	3 p 4 p 5 p	3 p 4 p 5 p	3 p 4 p 5 p	3 p 4 p 5 p
				4 h 4 h 4 h	6 h 9 h 9 h	9 h 6 h 6 h	7 h 7 h 7 h	10 h 10 h 10 h	2 h 2 h 2 h	2 h 2 h 2 h	2 h 2 h 2 h	2 h 2 h 2 h	2 h 2 h 2 h
 <p>Panel mounted inlet screw terminals</p> <p>IP44 Std. Pack: 10</p>	16	4			372	373							
	16	5				379							
	32	3	380		381								
	32	4			384	385							
	32	5				391							
 <p>Panel mounted inlet with hinged lid</p> <p>IP44 Std. Pack: 10</p>	16	4	392		393	394	395						
	16	5	398		399	400							
	32	3			402	403							
	32	4			405	406	407						
	32	5	410		411	412							



to IEC 60309-2, EN IEC 60309-2, DIN EN IEC 60309-2 (VDE 0623-2). Other voltages and frequencies available on request.

PRODUCT INFORMATION

		A	P	110 V 50 a. 60 Hz	230 V 50 a. 60 Hz	400 V 50 a. 60 Hz	500 V 50 a. 60 Hz	>50 - 500 V					
				3 p 4 p 5 p 4 h 4 h 4 h	3 p 4 p 5 p 6 h 9 h 9 h	3 p 4 p 5 p 9 h 6 h 6 h	3 p 4 p 5 p 7 h 7 h 7 h	100-300 Hz			300-500 Hz		
				3 p 4 p 5 p	3 p 4 p 5 p	3 p 4 p 5 p	3 p 4 p 5 p	3 p 4 p 5 p	3 p 4 p 5 p	3 p 4 p 5 p	3 p 4 p 5 p	3 p 4 p 5 p	3 p 4 p 5 p
 <p>Panel mounted inlet a retaining nose to hold the hinged lid of the connector must be provided by the customer in order to ensure satisfactory locking</p> <p>IP44 Std. Pack: 10</p>	16	5				1408							
	32	5				1409							
 <p>Panel mounted inlet a retaining nose to hold the hinged lid of the connector must be provided by the customer in order to ensure satisfactory locking</p> <p>IP44 Std. Pack: 10</p>	16	5				853							
 <p>Panel mounted inlet nickel plated contacts, a retaining nose to hold the hinged lid of the connector must be provided by the customer in order to ensure satisfactory locking</p> <p>IP44 Std. Pack: 10</p>	16	3			812								
	16	4			837	813	814						
	16	5				815							
	32	3			817								
	32	4			838	819	820						
	32	5				821							

to IEC 60309-2, EN IEC 60309-2, DIN EN IEC 60309-2 (VDE 0623-2). Other voltages and frequencies available on request.

PRODUCT INFORMATION

	A	P	110 V	230 V	400 V	500 V	>50 - 500 V					
			50 a. 60 Hz	50 a. 60 Hz	50 a. 60 Hz	50 a. 60 Hz	100-300 Hz		300-500 Hz			
			3 p 4 p 5 p	3 p 4 p 5 p	3 p 4 p 5 p	3 p 4 p 5 p	3 p 4 p 5 p	3 p 4 p 5 p	3 p 4 p 5 p			
			4 h 4 h 4 h	6 h 9 h 9 h	9 h 6 h 6 h	7 h 7 h 7 h	10 h 10 h 10 h	2 h 2 h 2 h				
 <p>Panel mounted inlet highly heat resistant contact carrier, nickel plated contacts, a retaining nose to hold the hinged lid of the connector must be provided by the customer in order to ensure satisfactory locking</p> <p>IP44 Std. Pack: 5</p>	63	3		1981								
	63	4		1984	1982	824						
	63	5			1688							
 <p>Panel mounted inlet nickel plated contacts, a retaining nose to hold the hinged lid of the connector must be provided by the customer in order to ensure satisfactory locking</p> <p>IP67 Std. Pack: 10</p>	16	3	825	826								
	16	4		839	827	828						
	16	5			829							
	32	3	830	831								
	32	4		840	832	833						
	32	5			834							
 <p>Panel mounted inlet highly heat resistant contact carrier, nickel plated contacts, 63 A: a retaining nose to hold the hinged lid of the connector must be provided by the customer in order to ensure satisfactory locking</p> <p>IP67 Std. Pack: 5</p>	63	3	835	836								
	63	4		3704	3656	3657						
	63	5			3658							
	125	3		3665								
	125	4		3413	3583	3600						
	125	5			1983							

to IEC 60309-2, EN IEC 60309-2, DIN EN IEC 60309-2 (VDE 0623-2). Other voltages and frequencies available on request.

PRODUCT INFORMATION

	A	P	110 V	230 V	400 V	500 V	>50 - 500 V					
			50 a. 60 Hz	50 a. 60 Hz	50 a. 60 Hz	50 a. 60 Hz	100-300 Hz			300-500 Hz		
			3 p 4 p 5 p	3 p 4 p 5 p	3 p 4 p 5 p	3 p 4 p 5 p	3 p 4 p 5 p	3 p 4 p 5 p	3 p 4 p 5 p			
			4 h 4 h 4 h	6 h 9 h 9 h	9 h 6 h 6 h	7 h 7 h 7 h	10 h 10 h 10 h	2 h 2 h 2 h				
	16	5		3231	1414							
	32	4		3528	3460	3461						
	32	5		3232	1415							
	63	4		3420	1436	3917						
	63	5			1437							

IP44
Std. Pack: 5

Phase sequence test plug

Enables safe control of the direction of the rotating field for CEE receptacles.

According to VDE 0100-550 part 4.7 rotary current receptacles must be connected such that a right-hand rotating field is achieved - the receptacles seen from front in clockwise direction.

The test plug differs from a standard plug by its transparent enclosure indicating a right-hand or left-hand rotating field or a missing phase by means of two control lamps.

Correct rotating field: Green lamp lights up.

Incorrect rotating field: Red lamp lights up.



Phase missing: Both lamps light up.

The control lamps inside the transparent enclosure are arranged so as to be perfectly visible from all sides.





to IEC 60309-2, EN IEC 60309-2, DIN EN IEC 60309-2 (VDE 0623-2). Other voltages and frequencies available on request.

PRODUCT INFORMATION

	A	P	110 V			230 V			400 V			500 V			>50 - 500 V					
			50 a, 60 Hz			50 a, 60 Hz			50 a, 60 Hz			50 a, 60 Hz			100-300 Hz		300-500 Hz			
			3 p	4 p	5 p	3 p	4 p	5 p	3 p	4 p	5 p	3 p	4 p	5 p	3 p	4 p	5 p	3 p	4 p	5 p
			4 h	4 h	4 h	6 h	9 h	9 h	9 h	6 h	6 h	7 h	7 h	7 h	10 h	10 h	10 h	2 h	2 h	2 h
 <p>Phase inverter plug AM-TOP single part body, cable gland and sealing, strain relief and protection against kinking</p> <p>IP44 Std. Pack: 10</p>	16	4				338		339												
	16	5				318		319												
	32	4				396		397												
	32	5						322												
 <p>Phase inverter plug ProTOP cable gland and sealing, strain relief and protection against kinking, enclosure with thread lock and safety slide</p> <p>IP44 Std. Pack: 10</p>	16	5						3319A												
	32	5						3322												
 <p>Phase inverter plug AM-TOP single part body, cable gland and sealing, strain relief and protection against kinking</p> <p>IP67 Std. Pack: 10</p>	16	4				3338		3339												
	16	5						325												
	32	4				3340		3341												
	32	5				327		328												



to IEC 60309-2, EN IEC 60309-2, DIN EN IEC 60309-2 (VDE 0623-2). Other voltages and frequencies available on request.

PRODUCT INFORMATION

		A	P	110 V	230 V	400 V	500 V	>50 - 500 V					
				50 a. 60 Hz	50 a. 60 Hz	50 a. 60 Hz	50 a. 60 Hz	100-300 Hz			300-500 Hz		
				3 p 4 p 5 p	3 p 4 p 5 p	3 p 4 p 5 p	3 p 4 p 5 p	3 p 4 p 5 p	3 p 4 p 5 p	3 p 4 p 5 p	3 p 4 p 5 p	3 p 4 p 5 p	3 p 4 p 5 p
				4 h 4 h 4 h	6 h 9 h 9 h	9 h 6 h 6 h	7 h 7 h 7 h	10 h 10 h 10 h	2 h 2 h 2 h	2 h 2 h 2 h	2 h 2 h 2 h	2 h 2 h 2 h	2 h 2 h 2 h
 <p>Wall mounted phase inverter inlet external fixing</p> <p>IP44 Std. Pack: 10</p>	16	5				3517							
	32	5				3523							
 <p>Wall mounted phase inverter inlet</p> <p>IP44 Std. Pack: 10</p>	16	4				3343							
	16	5				2511							
	32	4			3345	3346							
	32	5				2478							
 <p>Panel mounted phase inverter inlet</p> <p>IP44 Std. Pack: 10</p>	16	5				329							
	32	4				3368							
	32	5			913	330							



to IEC 60309-2, EN IEC 60309-2, DIN EN IEC 60309-2 (VDE 0623-2). Other voltages and frequencies available on request.

PRODUCT INFORMATION

		A	P	110 V	230 V	400 V	500 V	>50 - 500 V					
				50 a. 60 Hz	50 a. 60 Hz	50 a. 60 Hz	50 a. 60 Hz	100-300 Hz			300-500 Hz		
				3 p 4 p 5 p	3 p 4 p 5 p	3 p 4 p 5 p	3 p 4 p 5 p	3 p 4 p 5 p	3 p 4 p 5 p	3 p 4 p 5 p	3 p 4 p 5 p	3 p 4 p 5 p	3 p 4 p 5 p
				4 h 4 h 4 h	6 h 9 h 9 h	9 h 6 h 6 h	7 h 7 h 7 h	10 h 10 h 10 h	2 h 2 h 2 h	2 h 2 h 2 h	2 h 2 h 2 h	2 h 2 h 2 h	2 h 2 h 2 h
 <p>Panel mounted phase inverter inlet with hinged lid</p> <p>IP44 Std. Pack: 10</p>	16	4			3348	3350							
	16	5				20970							
	32	4				3356							
	32	5			3717	21241							
 <p>Panel mounted phase inverter inlet a retaining nose to hold the hinged lid of the connector must be provided by the customer in order to ensure satisfactory locking</p> <p>IP44 Std. Pack: 10</p>	16	5				854							



to IEC 60309-2, EN IEC 60309-2, DIN EN IEC 60309-2 (VDE 0623-2). Other voltages and frequencies available on request.

PRODUCT INFORMATION

		A	P	110 V 50 a. 60 Hz	230 V 50 a. 60 Hz	400 V 50 a. 60 Hz	500 V 50 a. 60 Hz	>50 - 500 V	
				3 p 4 p 5 p 4 h 4 h 4 h	3 p 4 p 5 p 6 h 9 h 9 h	3 p 4 p 5 p 9 h 6 h 6 h	3 p 4 p 5 p 7 h 7 h 7 h	100-300 Hz 3 p 4 p 5 p 10 h 10 h 10 h	300-500 Hz 3 p 4 p 5 p 2 h 2 h 2 h
 <p>Connector PowerTOP Xtra S with SafeCONTACT screwless, with insulation displacement technology, X-CONTACT, ergonomic enclosure design with nubbed grip zones, rubberised cable gland with sealing, strain relief and protection against kinking</p> <p>IP54 Std. Pack: 10</p>	16	3		14521					
	16	5			14522				
	32	5			14523				
 <p>Connector PowerTOP Xtra with ErgoCONTACT screw connection technology ErgoCONTACT, X-CONTACT, ergonomic enclosure design with nubbed grip zones, rubberised cable gland with sealing, strain relief and protection against kinking</p> <p>IP54 Std. Pack: 10</p>	16	3	14501*	14502	14503*				
	16	4	14504*	14505*	14506	14507*	14508*		
	16	5		14509	14510	14511			
	32	3	14512*	14513	14514*				
	32	4		14515*	14516	14517*	14518*		
	32	5		14519	14520				
	* Available from 01.06.2024								
 <p>Connector PowerTOP Xtra R with ErgoCONTACT screw connection technology ErgoCONTACT, X-CONTACT, ergonomic enclosure design with nubbed grip zones, highly heat resistant contact carrier, nickel plated contacts, rubberised cable gland with sealing</p> <p>IP54 Std. Pack: 10</p>	16	3	14550*	14551*		14553*	14554*	14555*	
	16	4	14556*	14557*	14558*	14559*		14560*	
	16	5	14561	14562	14563		14565	14567	
	32	3	14572*	14573*	14574*		14575*	14576*	
	32	4	14577*	14578*	14579*	14580*		14581*	
	32	5	14582		14584	14585	14586	14587	
	* Available from 01.06.2024								



to IEC 60309-2, EN IEC 60309-2, DIN EN IEC 60309-2 (VDE 0623-2). Other voltages and frequencies available on request.

PRODUCT INFORMATION

	A	P	110 V	230 V	400 V	500 V	>50 - 500 V					
			50 a. 60 Hz	50 a. 60 Hz	50 a. 60 Hz	50 a. 60 Hz	100-300 Hz			300-500 Hz		
			3 p 4 p 5 p	3 p 4 p 5 p	3 p 4 p 5 p	3 p 4 p 5 p	3 p 4 p 5 p	3 p 4 p 5 p	3 p 4 p 5 p			
			4 h 4 h 4 h	6 h 9 h 9 h	9 h 6 h 6 h	7 h 7 h 7 h	10 h 10 h 10 h	2 h 2 h 2 h				
 <p>Connector PowerTOP Xtra with ErgoCONTACT screw connection technology ErgoCONTACT, X-CONTACT, ergonomic enclosure design with nubbed grip zones, rubberised bayonet ring, sealed against dust, temporary submersion and high-pressure cleaning IP67 / IP69 Std. Pack: 10</p>	16	3	14619*	14620*								
	16	4		14621**	14622**	14623**						
	16	5			14624*							
	32	3		14625**								
	32	4		14626**	14627**	14628**						
	32	5			14629*							
* Available from 01.08.2024						** Available from 01.11.2024						
 <p>Connector PowerTOP Xtra R with ErgoCONTACT screw connection technology ErgoCONTACT, X-CONTACT, ergonomic enclosure design with nubbed grip zones, highly heat resistant contact carrier, nickel plated contacts, rubberised bayonet ring, sealed against dust, temporary submersion and high-pressure cleaning IP67 / IP69 - Std. Pack: 10</p>	16	3	14630*	14631*	14632*							
	16	4	14635**	14636**	14637**	14638**	14639**	14640**				
	16	5	14641*	14642*	14643*	14644*						
	32	3	14649**	14650**	14651**							
	32	4	14652**	14653**	14654**	14655**	14656**	14657**				
	32	5	14658*	14659*	14660*							
* Available from 01.08.2024						** Available from 01.11.2024						
 <p>Connector PowerTOP Xtra X-CONTACT, rubberised grip area, highly heat resistant contact carrier, frame terminals, cable gland and sealing, strain relief and protection against knicking, enclosure with thread lock, two safety slides IP54 Std. Pack: 5</p>	63	3	14101	14102								
	63	4		14105	14106	14107						
	63	5		14111	14112							

to IEC 60309-2, EN IEC 60309-2, DIN EN IEC 60309-2 (VDE 0623-2). Other voltages and frequencies available on request.

PRODUCT INFORMATION

	A	P	110 V	230 V	400 V	500 V	>50 - 500 V					
			50 a, 60 Hz	50 a, 60 Hz	50 a, 60 Hz	50 a, 60 Hz	100-300 Hz			300-500 Hz		
			3 p 4 p 5 p	3 p 4 p 5 p	3 p 4 p 5 p	3 p 4 p 5 p	3 p 4 p 5 p	3 p 4 p 5 p	3 p 4 p 5 p			
			4 h 4 h 4 h	6 h 9 h 9 h	9 h 6 h 6 h	7 h 7 h 7 h	10 h 10 h 10 h	2 h 2 h 2 h				
 <p>Connector PowerTOP Xtra X-CONTACT, rubberised grip area, highly heat resistant contact carrier, frame terminals, cable gland and sealing, strain relief and protection against knicking, enclosure with thread lock, two safety slides</p> <p>IP67 Std. Pack: 5</p>	63	3	14201	14202	14203							
	63	4	14204	14205	14206	14207	14208	14209				
	63	5	14210	14211	14212	14213			14214			
	125	3	14215	14216								
	125	4	14217	14218	14219	14220						
	125	5	14223	14224	14225	14226				14227		
 <p>Hanging clip for PowerTOP Xtra plugs and connectors</p> <p>Std. Pack: 100</p>			for 16 A, 3 to 5 p and 32 A, 3 + 4 p				15453000					
			for 32 A, 5 p				15452000					

AMAXX Receptacle combinations for worldwide use.

Our AMAXX receptacle combinations are versatile and highly customisable. Therefore, AMAXX is in operation worldwide in various fields, even under adverse conditions. Our slogan „AMAXX your Industry!“ goes round the world. Many international reference projects of satisfied customers are proof. What could be the reason? MENNEKES is the global specialist for industrial plugs and receptacles with over 80 years of experience. We should also mention the numerous options of the AMAXX combination programme and our passion to develop customised solutions – right up to one-off production. With new features to meet international requirements, such as UL listed enclosures and components, we are even better positioned in new markets.

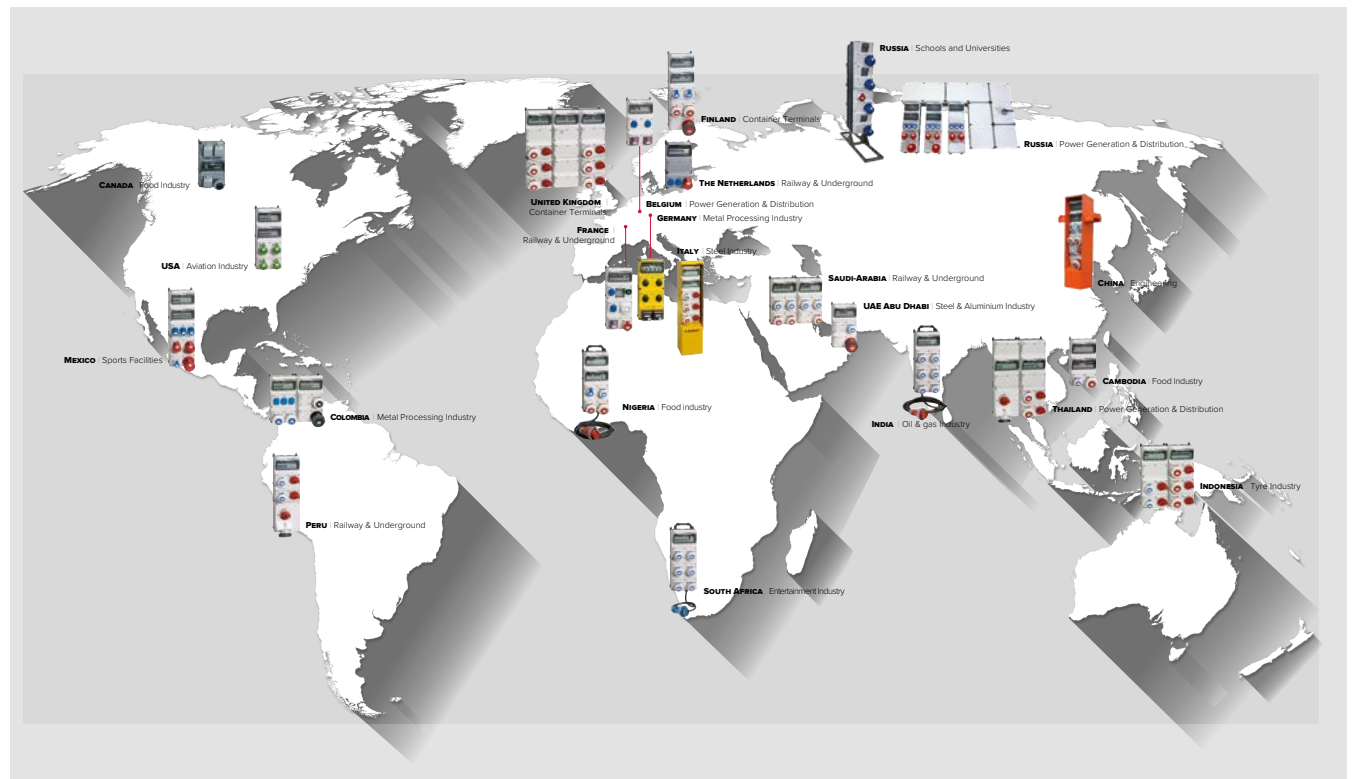

AMAXX Receptacle combinations for worldwide use.

Railway and Underground
Metro Riyadh, Saudi Arabia



CUSTOMISED PROJECT ENGINEERING

- according to national standards and specifications of railway operators
- 2 AMAXX with 3 segments
- **Protection type IP67**
- **CEE receptacles 16 A**
- Miniature circuit breaker (MCB)

BENEFITS OF AMAXX

- Manufacture based on IEC / EN IEC 60309 series and IEC / EN IEC 61439 series



AMAXX Receptacle combinations for worldwide use.



Entertainment Industry

Lighthouse Chapel, South Africa



CUSTOMISED PROJECT

ENGINEERING

- AMAXX with 4 segments
Mobile with carrying handle
- **Protection type IP67**
- **Supply cable of 1 m length with CEE plug 32 A**
- CEE receptacles
- RCD and MCB

BENEFITS OF AMAXX

- Manufacture based on IEC / EN IEC 60309 series and IEC / EN IEC 61439 series

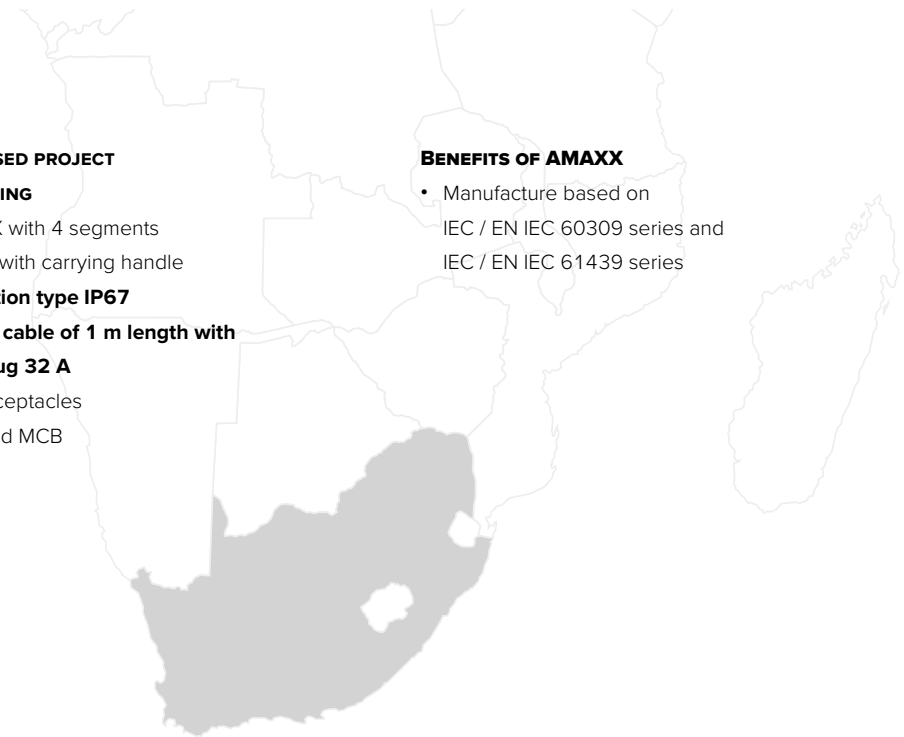

AMAXX Receptacle combinations for worldwide use.

Food Industry

Nigerian Bottling Company, Nigeria



CUSTOMISED PROJECT

ENGINEERING

- AMAXX with 4 segments
Mobile with carrying handle
- **Protection type IP67**
- **Supply cable of 20 m length
with CEE plug 32 A**
- **Grounding-type receptacle
British standard (IP68)**
- CEE receptacles
- RCD and MCB

BENEFITS OF AMAXX

- Manufacture based on
IEC / EN IEC 60309 series and
IEC / EN IEC 61439 series



AMAXX Receptacle combinations for worldwide use.



Steel & Aluminium Industry

EMAL (Emirates Aluminium), United Arab Emirates, Abu Dhabi



CUSTOMISED PROJECT

ENGINEERING

- AMAXX with 3 segments
- **Protection type IP67**
- **CEE receptacles up to 63 A**
- RCD and MCB

BENEFITS OF AMAXX

- Manufacture based on IEC / EN IEC 60309 series and IEC / EN IEC 61439 series

AMAXX Receptacle combinations for worldwide use.

Variety of versions.

- Protection type: IP44 and IP67
- Enclosure made of high-quality plastic or AMELAN in aggressive atmospheres with high resistance to chemicals as well as highly heat resistant contact carrier and nickel plated contacts
- Equipped with: CEE receptacles from 16 A, 3 p up to 63 A, 5 p, grounding-type receptacles in acc. with many national standards, DUO receptacles switched and interlocked from 16 A, 3 p up to 32 A, 5 p as well as fuse elements



AMAXX Receptacle combinations for worldwide use.

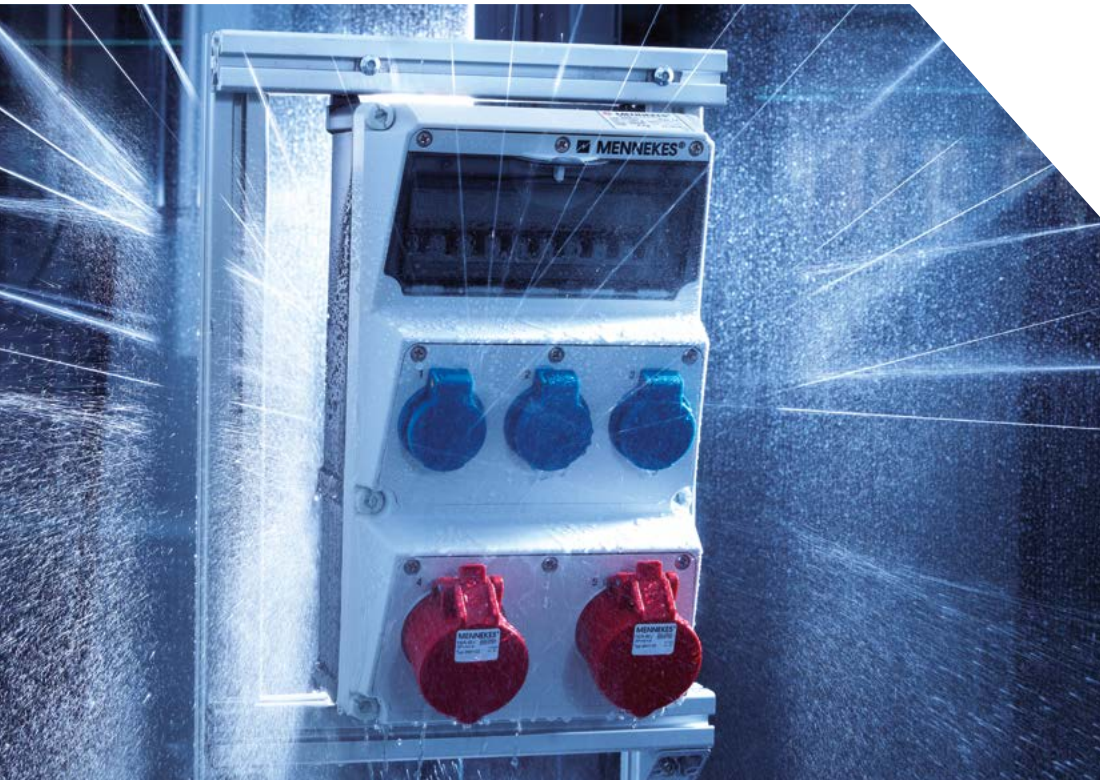

You can rely on it.

MENNEKES quality: tested and certified.

Like all other MENNEKES combinations, the AMAXX products are also subject to the extensive MENNEKES quality control. Each AMAXX combination is thoroughly tested and certified prior to delivery.

<h3>ZERTIFIKAT</h3> <p>CERTIFICATE</p> <p>für stückgeprüfte Qualität nach DIN EN 61439.</p> <p>for individually tested quality according to IEC 61439.</p> <div style="border: 1px solid black; height: 40px; width: 100%;"></div> <p><small>Hiermit bestätigen wir, dass diese Steckdosen-Kombination einer Stückprüfung unterzogen wurde. Herewith we confirm that this receptacle combination has passed a routine test.</small></p> <p><small>Der MENNEKES-Sicherheitstest berücksichtigt nicht nur die elektrischen Prüfanforderungen nach DIN EN 61439, sondern beinhaltet darüber hinaus auch eine allpolige Hochspannungsprüfung. The MENNEKES safety test not just include the requirements for electrical tests acc. to IEC 61439 but also a high voltage test for all poles.</small></p> <p><i>Dietmar Lächer</i></p> <p>Dietmar Lächer Bereichsleiter Qualität / Division Manager Quality</p>	
<p><small>MENNEKES Elektrotechnik GmbH & Co. KG Alteyl-Mennekes-Strasse 1 57399 KIRCHLINDEN / GERMANY</small></p>	<p><small>Phone: +49 2723 41-1 Fax: +49 2723 41-214 www.MENNEKES.de</small></p>

AMAXX Receptacle combinations for worldwide use.

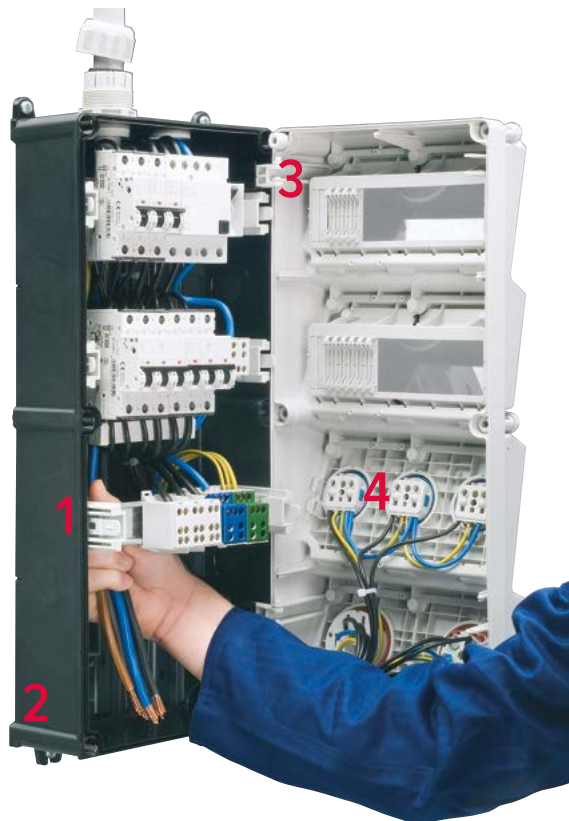

Easy to install. Sophisticated details.

1

Liftable DIN rails

Liftable DIN rails and a large, smooth wiring space significantly ease the insertion as well as connection of large cables

2

One-man installation

Shorter installation times with the new, user-friendly external fixing

3

Hinged cover

The hinged cover, which opens to one side, eases connection work

4

Ready for application

All combinations are pre-wired for installation and tested for electric safety and quality

AMAXX Receptacle combinations for worldwide use.



- Generally angled insertion direction, also with receptacles SCHUKO®



- Both hands free because inspection windows fold downwards



- Especially fast opening and closing of the enclosure due to captive double-threaded cover screws



- Window can be locked with a padlock, enclosure can be sealed

AMAXX Receptacle combinations for worldwide use.

Standard for low voltage switchgear and control gear assemblies - IEC 61439.

The standard IEC 61439 describes the design and test specifications for low voltage switchgear and control gear assemblies. The standard has implications for the distribution of electrical energy in industry, domestic electrical installations and on construction sites.

Two main standards are required for each type of low-voltage switchgear and controlgear assembly:

- the basic standard that is referenced as „Part 1“ in the specific standards;
- the applicable parts 2 to 7 of the switchgear and control gear assembly standard that deal with the particularities of the application.

In the [Service tab](#) you will find additional information, excerpts from the standard for low voltage switchgear and control gear assemblies - IEC 61439, and a listing of the agreements between manufacturers of the switchgear and control gear assemblies and users.

AMAXX Receptacle combinations for worldwide use.

What has changed with the switchgear standard – IEC 61439 and what are the benefits for the MENNEKES customer?

- **Product safety**

In the future, all low voltage switchgear and control gear assemblies must be tested in accordance with IEC 61439. The requirement of design verification is new. Design verification replaces the type test. MENNEKES receptacle combinations are subjected to additional standard-compliant routine tests. The outgoing circuits are individually loaded with the respective rated current.

Your advantage: This guarantees an even higher standard of safety.

- **Clear documentation**

Significant rating plate – clearly defined mandatory information, such as rated diversity factor RDF (previously: simultaneity factor).

Your advantage: The main technical product information is visible on the rating plate at a glance.

- **Clear specifications**

Requests for a custom solution require clearly defined specifications by the user (such as installation site, ambient temperatures, etc.).

Your advantage: You get a need-based solution by MENNEKES tailored to the specific application.

- **Distinction:**

Original manufacturer – manufacturer
If a product is modified on site, the company in question is considered to be the manufacturer. In this case a new verification and documentation are required from this company.

Your advantage: For receptacle combinations that are pre-wired for installation, MENNEKES is the original manufacturer and manufacturer and therefore bears the complete product responsibility.

AMAXX Receptacle combinations for worldwide use.

Example – rating plate



MENNEKES

Typ:
 $I_{nA} : 40A$ **RDF** 0,8
 $U_n : 230/400V \sim$ $I_{cc} \leq 10 \text{ kA}$
 $f_n : 100-300 \text{ Hz}$ **IP44**
Vorsicherung (Fuse): 63 A
 IEC 61439-3 PNF 27

CE **DVE**

IP

I_{nA} Rated current of the switchgear and control gear assembly

U_n Rated voltage

f_n Rated frequency

RDF Rated diversity factor

I_{cc} Conditional rated short-circuit current

Protection class

Ingress protection

AMAXX Receptacle combinations

Drawings and dimensions.

AMAXX with 1 segment

AMAXX with 2 segments

AMAXX with 3 segments

1 MB 531

Depth dimensions of the AMAXX enclosures with 1, 2 or 3 segments and various fittings.

Receptacles	IP-degrees	Depth
SCHUKO® 16 A, 230 V	44	175 mm
	67	194 mm
CEE 16 A, 3 p, 230 V	44	204 mm
	67	205 mm
CEE 16 A, 5 p, 400 V	44	209 mm
	67	213 mm
CEE 32 A, 5 p, 400 V	44	221 mm
	67	227 mm
CEE 63 A, 5 p, 400 V	44	248 mm
	67	248 mm

1 MB 521

Cable entries: closed for cut out.

single enclosure 130 mm x 225 mm:
2 x M 25 each on top and bottom

double enclosure 260 mm x 225 mm:
2 x M 32 each on top and bottom

triple enclosure 390 mm x 225 mm:
2 x M 40 each on top and bottom

1 MB 522

For all enclosures: 2 x M 20 each on top and bottom for cut out.

AMAXX Receptacle combinations

Drawings and dimensions.

AMAXX with 4 segments

AMAXX with 5 segments

AMAXX s (5 segments)

1 MB 523

Depth dimensions of the AMAXX enclosures with 4 or 5 segments and various fittings.

Receptacles	IP-degrees	Depth
SCHUKO® 16 A, 230 V	44	186 mm
	67	208 mm
CEE 16 A, 3 p, 230 V	44	216 mm
	67	220 mm
CEE 16 A, 5 p, 400 V	44	222 mm
	67	226 mm
CEE 32 A, 5 p, 400 V	44	231 mm
	67	236 mm
CEE 63 A, 5 p, 400 V	44	260 mm
	67	260 mm

1 MB 540

Cable entries: closed for cut out.

quadruple enclosure 520 mm x 225 mm:

quintuple enclosure 650 mm x 225 mm:

2 x M 40 each on top and bottom

For both enclosures: 2 x M 20 each on top and bottom for cut out.

Depth dimensions of the AMAXX s enclosures with 5 segments and various fittings.

Receptacles	IP-degrees	Depth
SCHUKO® 16 A, 230 V	44	140 mm
	67	157 mm
CEE 16 A, 3 p, 230 V	44	170 mm
	67	169 mm
CEE 16 A, 5 p, 400 V	44	172 mm
	67	174 mm
CEE 32 A, 5 p, 400 V	44	182 mm
	67	188 mm

Cable entries: closed for cut out.

AMAXX s 650 mm x 112.5 mm:
1 x M 25 each on top and bottom or
1 x M 32 each on top and bottom

Additionally: 1 x M 20 each on top and bottom to cut out.

1 MB 541

AMAXX Receptacle combinations

Drawings and dimensions.

Suspendable AMAXX

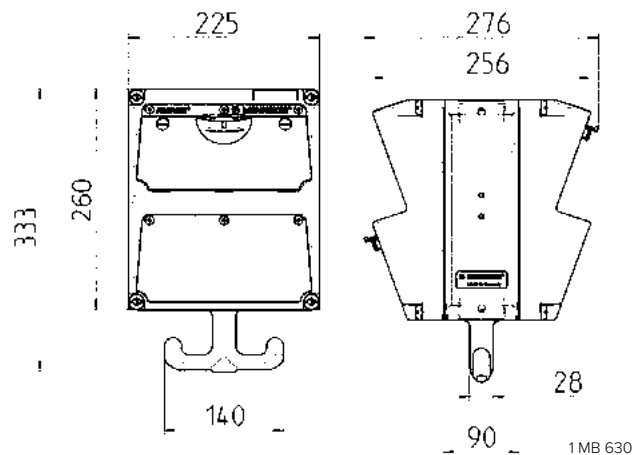

Depth dimensions for identical configuration on both sides.

Receptacles	IP-degrees	Depth
SCHUKO® 16 A, 230 V	IP44	282 mm
	IP67	326 mm
CEE 16 A, 3 p, 230 V	IP44	342 mm
	IP67	350 mm
CEE 16 A, 5 p, 400 V	IP44	354 mm
	IP67	362 mm
CEE 32 A, 5 p, 400 V	IP44	372 mm
	IP67	382 mm

Cable entries: closed for cut out

1 x M 32 on top, 1 x M 25 on top and 1 x M 20 on top



Pre-wired for installation, wall mounted receptacle combinations, mobile, suspended, Protection type IP44 / IP67,  highly resistant to chemicals. Further combinations on request.

CEE 5 p, 400 V			CEE 3 p, 230 V	CEE 3 p, 110 V	Receptacles SCHUKO®, Receptacles NF, Receptacles British standard	Fusing		Protection type	Special features	Part no.
63 A	32 A	16 A	16 A	16 A		RCD	MCB			
					2 SCHUKO® 16 A, 230 V	1 RCD 25 A, 2 p, 0.03 A	2 MCB's 16 A, 1 p, C	IP44		910001
					2 NF 16 A, 2 p+E, 230 V	1 RCD 25 A, 2 p, 0.03 A	2 MCB's 16 A, 1 p+N, C	IP44		910205
					3 SCHUKO® 16 A, 230 V	1 RCD 40 A, 4 p, 0.03 A	3 MCB's 16 A, 1 p, C	IP44		920003
					3 NF 16 A, 2 p+E, 230 V	1 RCD 40 A, 4 p, 0.03 A	3 MCB's 16 A, 1 p+N, C	IP44		920043
					3 SCHUKO® 16 A, 230 V			IP44	mobile	910031
					5 NF 16 A, 2 p+E, 230 V	1 RCD 25 A, 2 p, 0.03 A		IP44	mobile	920046
				2				IP44		910214
			2			1 RCD 25 A, 2 p, 0.03 A		IP67		920821
			2					IP67		910355
			3			1 RCD 40 A, 4 p, 0.03 A	3 MCB's 16 A, 1 p, C	IP44		960019 ¹⁾
			3			1 RCD 40 A, 4 p, 0.03 A	1 MCB 16 A, 3 p+N, C	IP67	mobile	940030 ³⁾
			3					IP44		910015

¹⁾ AMAXX s (narrow design)

³⁾ switched, with mechanical DUO-interlock

Pre-wired for installation, wall mounted receptacle combinations, mobile, suspended, Protection type IP44 / IP67,  highly resistant to chemicals. Further combinations on request.

CEE 5 p, 400 V			CEE 3 p, 230 V	CEE 3 p, 110 V	Receptacles SCHUKO®, Receptacles NF, Receptacles British standard	Fusing		Protection type	Special features	Part no.
63 A	32 A	16 A	16 A	16 A		RCD	MCB			
		1						IP67		7626 ³⁾
		1			2 NF 16 A, 2 p+E, 230 V	1 RCD 40 A, 4 p, 0.03 A	1 MCB 16 A, 3 p+N, C 2 MCB's 16 A, 1 p+N, C	IP44		920283
		1			2 SCHUKO® 16 A, 230 V	1 RCD 40 A, 4 p, 0.03 A	1 MCB 16 A, 3 p, C 1 MCB 16 A, 1 p, C	IP44		960051 ²⁾
		1			2 SCHUKO® 16 A, 230 V		1 MCB 16 A, 3 p, C 2 MCB's 16 A, 1 p, C	IP44		920005
		1			2 SCHUKO® 16 A, 230 V			IP44		910007
		1			2 SCHUKO® 16 A, 230 V			IP44		910020
		1			3 SCHUKO® 16 A, 230 V	1 RCD 40 A, 4 p, 0.03 A	1 MCB 16 A, 3 p, C 3 MCB's 16 A, 1 p, C	IP67		930022
		1			3 NF 16 A, 2 p+E, 230 V	1 RCD 40 A, 4 p, 0.03 A	1 MCB 16 A, 3 p, C 3 MCB's 16 A, 1 p+N, C	IP67		930520 ⁶⁾
		1			3 SCHUKO® 16 A, 230 V	1 RCD 40 A, 4 p, 0.03 A	1 MCB 16 A, 3 p, C 3 MCB's 16 A, 1 p, C	IP67		930027
		1			3 SCHUKO® 16 A, 230 V		1 MCB 16 A, 3 p, C 1 MCB 16 A, 1 p, C	IP44		960004 ¹⁾

¹⁾ AMAXX s (narrow design)

²⁾ AMAXX s with swiveling fram (connection via flexible supply line)

³⁾ switched, with mechanical DUO-interlock

⁶⁾ 16 A, 4 p, 400 V

Pre-wired for installation, wall mounted receptacle combinations, mobile, suspended, Protection type IP44 / IP67, highly resistant to chemicals. Further combinations on request.

CEE 5 p, 400 V			CEE 3 p, 230 V	CEE 3 p, 110 V	Receptacles SCHUKO®, Receptacles NF, Receptacles British standard	Fusing		Protection type	Special features	Part no.
63 A	32 A	16 A	16 A	16 A		RCD	MCB			
		1			4 SCHUKO® 16 A, 230 V			IP67		960031 ¹⁾
		2					2 MCB's 16 A, 3 p, C	IP44		930031 ³⁾
		2			3 SCHUKO® 16 A, 230 V		2 MCB's 16 A, 3 p, C 3 MCB's 16 A, 1 p, C	IP44		930003
		2			3 x 13 A, 2 p+E, 240 V		2 MCB's 16 A, 3 p, C 3 MCB's 13 A, 1 p, C	IP44		930734
		2			4 SCHUKO® 16 A, 230 V	1 RCD 40 A, 4 p, 0.03 A	2 MCB's 16 A, 3 p, C 4 MCB's 16 A, 1 p, C	IP44	suspended	970004GE
	1				2 NF 16 A, 2 p+E, 230 V	1 RCD 40 A, 4 p, 0.03 A	1 MCB 32 A, 3 p+N, C 2 MCB's 16 A, 1 p+N, C	IP44		920294
	1				2 SCHUKO® 16 A, 230 V		1 MCB 32 A, 3 p, C 2 MCB's 16 A, 1 p, C	IP44		920011
	1				3 SCHUKO® 16 A, 230 V	1 RCD 40 A, 4 p, 0.03 A	1 MCB 32 A, 3 p, C 3 MCB's 16 A, 1 p, C	IP67		930028
	1	1			2 SCHUKO® 16 A, 230 V	1 RCD 63 A, 4 p, 0.03 A	1 MCB 32 A, 3 p, C 1 MCB 16 A, 3 p, C 2 MCB's 16 A, 1 p, C	IP67		940016
	1	1			2 NF 16 A, 2 p+E, 230 V	1 RCD 40 A, 4 p, 0.03 A	1 MCB 32 A, 3 p+N, C 1 MCB 16 A, 3 p+N, C 2 MCB's 16 A, 1 p+N, C	IP44		930035

¹⁾ AMAXX s (narrow design)

³⁾ switched, with mechanical DUO-interlock

Pre-wired for installation, wall mounted receptacle combinations, mobile, suspended, Protection type IP44 / IP67,  highly resistant to chemicals. Further combinations on request.

CEE 5 p, 400 V			CEE 3 p, 230 V	CEE 3 p, 110 V	Receptacles SCHUKO®, Receptacles NF, Receptacles British standard	Fusing		Protection type	Special features	Part no.
63 A	32 A	16 A	16 A	16 A		RCD	MCB			
	1	1			2 SCHUKO® 16 A, 230 V	1 RCD 40 A, 4 p, 0.03 A	1 MCB 32 A, 3 p, C 1 MCB 16 A, 3 p, C 2 MCB's 16 A, 1 p, C	IP44		940018 ⁴⁾
	1	1			3 SCHUKO® 16 A, 230 V	1 RCD 40 A, 4 p, 0.03 A	1 MCB 32 A, 3 p, C 1 MCB 16 A, 3 p, C 3 MCB's 16 A, 1 p, C	IP44		940005
	1	1			3 SCHUKO® 16 A, 230 V	1 RCD 40 A, 4 p, 0.03 A	1 MCB 16 A, 3 p, C 3 MCB's 16 A, 1 p, C	IP44	suspended	970002
	1	1			3 SCHUKO® 16 A, 230 V	1 RCD 40 A, 4 p, 0.03 A	1 MCB 16 A, 3 p, C 3 MCB's 16 A, 1 p, C	IP44	suspended	970005 ⁵⁾
	1	1			3 x 13 A, 2 p+E, 240 V	1 RCD 40 A, 4 p, 0.03 A	1 MCB 16 A, 3 p, C 3 MCB's 13 A, 1 p, C	IP44	mobile	931237
	1	1			3 SCHUKO® 16 A, 230 V		1 MCB 32 A, 3 p, C 1 MCB 16 A, 3 p, C 3 MCB's 16 A, 1 p, C	IP44		930011
	1	1			4 SCHUKO® 16 A, 230 V	1 RCD 40 A, 4 p, 0.03 A	1 MCB 32 A, 3 p, C 1 MCB 16 A, 3 p, C 4 MCB's 16 A, 1 p, C	IP44	suspended	970001GE
	1	1			6 SCHUKO® 16 A, 230 V	1 RCD 63 A, 4 p, 0.03 A	1 MCB 32 A, 3 p, C 1 MCB 16 A, 3 p, C 6 MCB's 16 A, 1 p, C	IP44		950004

⁴⁾ with 2 Cepex RJ45, 2 fold Cat.6

⁵⁾ with 1 Cepex RJ45, 2 fold Cat.6

Pre-wired for installation, wall mounted receptacle combinations, mobile, suspended, Protection type IP44 / IP67, highly resistant to chemicals. Further combinations on request.

CEE 5 p, 400 V			CEE 3 p, 230 V	CEE 3 p, 110 V	Receptacles SCHUKO®, Receptacles NF, Receptacles British standard	Fusing		Protection type	Special features	Part no.
63 A	32 A	16 A	16 A	16 A		RCD	MCB			
	1	2			4 NF 16 A, 2 p+E, 230 V	1 RCD 63 A, 4 p, 0.03 A	1 MCB 32 A, 3 p+N, C 2 MCB's 16 A, 3 p+N, C 4 MCB's 16 A 1 p+N, C	IP44		950020
	1	2	3				1 MCB 32 A, 3 p+N, C 1 MCB 16 A, 3 p, C 1 MCB 16 A, 1 p+N, C	IP67		940028⁶⁾
	2				3 NF 16 A, 2 p+E, 230 V	1 RCD 63 A, 4 p, 0.03 A	2 MCB's 32 A, 3 p+N, C 3 MCB's 16 A, 1 p+N, C	IP44		940286
	2	2				1 RCD 63 A, 4 p, 0.03 A	2 MCB's 32 A, 3 p, C 2 MCB's 16 A, 3 p, C	IP67		900005³⁾
	2	2				1 RCD 63 A, 4 p, 0.03 A	2 MCB's 32 A, 3 p, C 2 MCB's 16 A, 3 p, C	IP67		900946³⁾
	3						3 MCB's 32 A, 3 p, C 1 earth bolt M 10, V2A	IP67		940027^{3) 7)}
1	1	1			2 SCHUKO® 16 A, 230 V	1 RCD 63 A, 4 p, 0.03 A	1 MCB 32 A, 3 p, C 1 MCB 16 A, 3 p, C 2 MCB's 16 A, 1 p, C	IP67		950031
1	1	1			2 x 13 A, 2 p+E, 240 V	1 RCD 63 A, 4 p, 0.03 A	1 MCB 32 A, 3 p, C 1 MCB 16 A, 3 p, C 2 MCB's 13 A, 1 p, C	IP44		941137
1	1	1			2 NF 16 A, 2 p+E, 230 V	1 RCD 63 A, 4 p, 0.03 A	1 MCB 32 A, 3 p+N, C 1 MCB 16 A, 3 p+N, C 2 MCB's 16 A, 1 p+N, C	IP67		950033

³⁾ switched, with mechanical DUO-interlock

⁶⁾ 16 A, 4 p, 400 V





⁷⁾ 32 A, 4 p, 380-440 V

Pre-wired for installation, wall mounted receptacle combinations, mobile, suspended, Protection type IP44 / IP67,  highly resistant to chemicals. Further combinations on request.

CEE 5 p, 400 V			CEE 3 p, 230 V	CEE 3 p, 110 V	Receptacles SCHUKO®, Receptacles NF, Receptacles British standard	Fusing		Protection type	Special features	Part no.
63 A	32 A	16 A	16 A	16 A		RCD	MCB			
1	1	1			4 SCHUKO® 16 A, 230 V	1 RCD 63 A, 4 p, 0.03 A	1 MCB 32 A, 3 p, C 1 MCB 16 A, 3 p, C 4 MCB's 16 A, 1 p, C	IP44		<u>950041</u>
1	1	1			4 NF 16 A, 2 p+E, 230 V	1 RCD 63 A, 4 p, 0.03 A	1 MCB 32 A, 3 p+N, C 1 MCB 16 A, 3 p+N, C 4 MCB's 16 A, 1 p+N, C	IP44		<u>950022</u>

Pre-wired for installation, IP44, enclosure front cover light grey RAL 7035, hinged to the side (except enclosure size 130 x 225 mm and 650 x 112.5 mm). Fusing behind a transparent cover.
[Drawings and dimensions can be found here.](#)

PRODUCT INFORMATION

	CEE receptacles	CEE receptacles	Receptacles SCHUKO®	Fusing	Connection	Connection and load values	Enclosure size	Part no.
	CEE receptacles	CEE receptacles	Receptacles NF	Fusing	Connection	Connection and load values	Enclosure size	Part no.
			2 SCHUKO® 16 A, 230 V	1 RCD 25 A, 2 p, 0.03 A 2 MCB's 16 A, 1 p, C	For 1 cable up to 3 x 10 mm ²	Pre-fuse max. 25 A InA 25 A RDF 1	130 x 225 mm (H x W)	910001
			2 NF 16 A, 2 p+E, 230 V	1 RCD 25 A, 2 p, 0.03 A 2 MCB's 16 A, 1 p+N, C	For 1 cable up to 3 x 6 mm ²	Pre-fuse max. 25 A InA 25 A RDF 1	130 x 225 mm (H x W)	910205



Pre-wired for installation, IP44, enclosure front cover light grey RAL 7035, hinged to the side (except enclosure size 130 x 225 mm and 650 x 112.5 mm). Fusing behind a transparent cover.
[Drawings and dimensions can be found here.](#)

PRODUCT INFORMATION

	CEE receptacles	CEE receptacles	Receptacles SCHUKO®	Fusing	Connection	Connection and load values	Enclosure size	Part no.
			3 SCHUKO® 16 A, 230 V	1 RCD 40 A, 4 p, 0.03 A 3 MCB's 16 A, 1 p, C	For 1 cable up to 5 x 10 mm ²	Pre-fuse max. 100 A InA 16 A RDF 1	260 x 225 mm (H x W)	920003
	CEE receptacles	CEE receptacles	Receptacles NF	Fusing	Connection	Connection and load values	Enclosure size	Part no.
			3 NF 16 A, 2 p+E, 230 V	1 RCD 40 A, 4 p, 0.03 A 3 MCB's 16 A, 1 p+N, C	For 1 cable up to 5 x 10 mm ²	Pre-fuse max. 63 A InA 16 A RDF 1	260 x 225 mm (H x W)	920043



Pre-wired for installation, IP44, enclosure front cover light grey RAL 7035, hinged to the side (except enclosure size 130 x 225 mm and 650 x 112.5 mm). Fusing behind a transparent cover.
[Drawings and dimensions can be found here.](#)

PRODUCT INFORMATION

	CEE receptacles	CEE receptacles	Receptacles SCHUKO®	Fusing	Connection	Connection and load values	Enclosure size	Part no.
		2 CEE 16 A, 3 p, 110 V			For 2 cables up to 3 x 4 mm ²		130 x 225 mm (H x W)	910214
	CEE receptacles	CEE receptacles	Receptacles SCHUKO®	Fusing	Connection	Connection and load values	Enclosure size	Part no.
		3 CEE 16 A, 3 p, 230 V		1 RCD 40 A, 4 p, 0.03 A 3 MCB's 16 A, 1 p, C	For 1 cable up to 3 x 10 mm ²	Pre-fuse max. 40 A InA 40 A RDF 1	650 x 112.5 mm (H x W)	960019

Pre-wired for installation, IP44, enclosure front cover light grey RAL 7035, hinged to the side (except enclosure size 130 x 225 mm and 650 x 112.5 mm). Fusing behind a transparent cover.
[Drawings and dimensions can be found here.](#)





PRODUCT INFORMATION

	<p>CEE receptacles</p>	<p>CEE receptacles</p> <p>3 CEE 16 A, 3 p, 230 V</p>	<p>Receptacles SCHUKO®</p>	<p>Fusing</p>	<p>Connection</p> <p>For 1 cable up to 5 x 10 mm²</p>	<p>Connection and load values</p> <p>Pre-fuse max. 16 A InA 16 A RDF 1</p>	<p>Enclosure size</p> <p>130 x 225 mm (H x W)</p>	<p>Part no.</p> <p>910015</p>
	<p>CEE receptacles</p> <p>1 CEE 16 A, 5 p, 400 V</p>	<p>CEE receptacles</p>	<p>Receptacles NF</p> <p>2 NF 16 A, 2 p+E, 230 V</p>	<p>Fusing</p> <p>1 RCD 40 A, 4 p, 0.03 A 1 MCB 16 A, 3 p+N, C 2 MCB's 16 A, 1 p+N, C</p>	<p>Connection</p> <p>For 1 cable up to 5 x 10 mm²</p>	<p>Connection and load values</p> <p>Pre-fuse max. 63 A InA 27 A RDF 0.85</p>	<p>Enclosure size</p> <p>260 x 225 mm (H x W)</p>	<p>Part no.</p> <p>920283</p>





Pre-wired for installation, IP44, enclosure front cover light grey RAL 7035, hinged to the side (except enclosure size 130 x 225 mm and 650 x 112.5 mm). Fusing behind a transparent cover.
[Drawings and dimensions can be found here.](#)

PRODUCT INFORMATION

	CEE receptacles	CEE receptacles	Receptacles SCHUKO®	Fusing	Connection	Connection and load values	Enclosure size	Part no.
 	1 CEE 16 A, 5 p, 400 V		2 SCHUKO® 16 A, 230 V	1 RCD 40 A, 4 p, 0.03 A 1 MCB 16 A, 3 p, C 1 MCB 16 A, 1 p, C	For 1 cable up to 5 x 10 mm ²	Pre-fuse max. 63 A InA 32 A RDF 1	650 x 112.5 mm (H x W)	960051
 	1 CEE 16 A, 5 p, 400 V		2 SCHUKO® 16 A, 230 V	1 MCB 16 A, 3 p, C 2 MCB's 16 A, 1 p, C	For 1 cable up to 5 x 10 mm ²	Pre-fuse max. 63 A InA 32 A RDF 1	260 x 225 mm (H x W)	920005



Pre-wired for installation, IP44, enclosure front cover light grey RAL 7035, hinged to the side (except enclosure size 130 x 225 mm and 650 x 112.5 mm). Fusing behind a transparent cover.
[Drawings and dimensions can be found here.](#)

PRODUCT INFORMATION

	CEE receptacles	CEE receptacles	Receptacles SCHUKO®	Fusing	Connection	Connection and load values	Enclosure size (H x W)	Part no.
	1 CEE 16 A, 5 p, 400 V		2 SCHUKO® 16 A, 230 V		For 1 cable up to 5 x 10 mm ²	Pre-fuse max. 16 A I _{nA} 16 A RDF 1	130 x 225 mm (H x W)	910007
	1 CEE 16 A, 5 p, 400 V		3 SCHUKO® 16 A, 230 V	1 MCB 16 A, 3 p, C 1 MCB 16 A, 1 p, C	For 1 cable up to 5 x 10 mm ²	Pre-fuse max. 63 A I _{nA} 32 A RDF 1	650 x 112.5 mm (H x W)	960004

Pre-wired for installation, IP44, enclosure front cover light grey RAL 7035, hinged to the side (except enclosure size 130 x 225 mm and 650 x 112.5 mm). Fusing behind a transparent cover.
[Drawings and dimensions can be found here.](#)



PRODUCT INFORMATION

	<p>CEE receptacles</p> <p>2 CEE 16 A, 5 p, 400 V switched, with mechanical DUO-interlock</p>	<p>CEE receptacles</p>	<p>Receptacles SCHUKO®</p>	<p>Fusing</p> <p>2 MCB's 16 A, 3 p, C</p>	<p>Connection</p> <p>For 2 cables up to 5 x 25 mm²</p>	<p>Connection and load values</p> <p>Pre-fuse max. 100 A InA 32 A RDF 1</p>	<p>Enclosure size</p> <p>390 x 225 mm (H x W)</p>	<p>Part no.</p> <p>930031</p>
	<p>CEE receptacles</p> <p>2 CEE 16 A, 5 p, 400 V</p>	<p>CEE receptacles</p>	<p>Receptacles SCHUKO®</p> <p>3 SCHUKO® 16 A, 230 V</p>	<p>Fusing</p> <p>2 MCB's 16 A, 3 p, C 3 MCB's 16 A, 1 p, C</p>	<p>Connection</p> <p>For 2 cables up to 5 x 25 mm²</p>	<p>Connection and load values</p> <p>Pre-fuse max. 63 A InA 46 A RDF 0.95</p>	<p>Enclosure size</p> <p>390 x 225 mm (H x W)</p>	<p>Part no.</p> <p>930003</p>





Pre-wired for installation, IP44, enclosure front cover light grey RAL 7035, hinged to the side (except enclosure size 130 x 225 mm and 650 x 112.5 mm). Fusing behind a transparent cover.
[Drawings and dimensions can be found here.](#)

PRODUCT INFORMATION

	<p>CEE receptacles</p> <p>2 CEE 16 A, 5 p, 400 V</p>	<p>CEE receptacles</p>	<p>Receptacles British standard</p> <p>3 x 13 A, 2 p+E, 240 V</p>	<p>Fusing</p> <p>2 MCB's 16 A, 3 p, C 3 MCB's 13 A, 1 p, C</p>	<p>Connection</p> <p>For 2 cables up to 5 x 16 mm²</p>	<p>Connection and load values</p> <p>Pre-fuse max. 63 A InA 43 A RDF 0.95</p>	<p>Enclosure size</p> <p>390 x 225 mm (H x W)</p>	<p>Part no.</p> <p>930734</p>
	<p>CEE receptacles</p> <p>1 CEE 32 A, 5 p, 400 V</p>	<p>CEE receptacles</p>	<p>Receptacles NF</p> <p>2 NF 16 A, 2 p+E, 230 V</p>	<p>Fusing</p> <p>1 RCD 40 A, 4 p, 0.03 A 1 MCB 32 A, 3 p+N, C 2 MCB's 16 A, 1 p+N, C</p>	<p>Connection</p> <p>For 1 cable up to 5 x 10 mm²</p>	<p>Connection and load values</p> <p>Pre-fuse max. 40 A InA 34 A RDF 0.7</p>	<p>Enclosure size</p> <p>260 x 225 mm (H x W)</p>	<p>Part no.</p> <p>920294</p>



Pre-wired for installation, IP44, enclosure front cover light grey RAL 7035, hinged to the side (except enclosure size 130 x 225 mm and 650 x 112.5 mm). Fusing behind a transparent cover.
[Drawings and dimensions can be found here.](#)

PRODUCT INFORMATION

	CEE receptacles	CEE receptacles	Receptacles SCHUKO®	Fusing	Connection	Connection and load values	Enclosure size	Part no.
	1 CEE 32 A, 5 p, 400 V		2 SCHUKO® 16 A, 230 V	1 MCB 32 A, 3 p, C 2 MCB's 16 A, 1 p, C	For 1 cable up to 5 x 10 mm ²	Pre-fuse max. 63 A InA 48 A RDF 1	260 x 225 mm (H x W)	920011
	1 CEE 32 A, 5 p, 400 V 1 CEE 16 A, 5 p, 400 V		2 NF 16 A, 2 p+E, 230 V	1 RCD 40 A, 4 p, 0.03 A 1 MCB 32 A, 3 p+N, C 1 MCB 16 A, 3 p+N, C 2 MCB's 16 A, 1 p+N, C	For 1 cable up to 5 x 25 mm ²	Pre-fuse max. 40 A InA 38 A RDF 0.6	390 x 225 mm (H x W)	930035





Pre-wired for installation, IP44, enclosure front cover light grey RAL 7035, hinged to the side (except enclosure size 130 x 225 mm and 650 x 112.5 mm). Fusing behind a transparent cover.
[Drawings and dimensions can be found here.](#)

PRODUCT INFORMATION

	<p>CEE receptacles</p> <p>1 CEE 32 A, 5 p, 400 V 1 CEE 16 A, 5 p, 400 V</p>	<p>Data port sockets</p> <p>2 Cepex RJ45, 2 fold Cat.6</p>	<p>Receptacles SCHUKO®</p> <p>2 SCHUKO® 16 A, 230 V</p>	<p>Fusing</p> <p>1 RCD 40 A, 4 p, 0.03 A 1 MCB 32 A, 3 p, C 1 MCB 16 A, 3 p, C 2 MCB's 16 A, 1 p, C</p>	<p>Connection</p> <p>For 2 cables up to 5 x 25 mm²</p>	<p>Connection and load values</p> <p>Pre-fuse max. 40 A InA 40 A RDF 1</p>	<p>Enclosure size (H x W)</p> <p>520 x 225 mm</p>	<p>Part no.</p> <p>940018</p>
	<p>CEE receptacles</p> <p>1 CEE 32 A, 5 p, 400 V 1 CEE 16 A, 5 p, 400 V</p>	<p>CEE receptacles</p>	<p>Receptacles SCHUKO®</p> <p>3 SCHUKO® 16 A, 230 V</p>	<p>Fusing</p> <p>1 RCD 40 A, 4 p, 0.03 A 1 MCB 32 A, 3 p, C 1 MCB 16 A, 3 p, C 3 MCB's 16 A, 1 p, C</p>	<p>Connection</p> <p>For 2 cables up to 5 x 25 mm²</p>	<p>Connection and load values</p> <p>Pre-fuse max. 40 A InA 38 A RDF 0.6</p>	<p>Enclosure size (H x W)</p> <p>520 x 225 mm</p>	<p>Part no.</p> <p>940005</p>

Pre-wired for installation, IP44, enclosure front cover light grey RAL 7035, hinged to the side (except enclosure size 130 x 225 mm and 650 x 112.5 mm). Fusing behind a transparent cover.
[Drawings and dimensions can be found here.](#)

PRODUCT INFORMATION

	CEE receptacles	CEE receptacles	Receptacles SCHUKO®	Fusing	Connection	Connection and load values	Enclosure size	Part no.
 	1 CEE 32 A, 5 p, 400 V 1 CEE 16 A, 5 p, 400 V		3 SCHUKO® 16 A, 230 V	1 MCB 32 A, 3 p, C 1 MCB 16 A, 3 p, C 3 MCB's 16 A, 1 p, C	For 2 cables up to 5 x 25 mm ²	Pre-fuse max. 63 A InA 54 A RDF 0.85	390 x 225 mm (H x W)	930011
 	1 CEE 32 A, 5 p, 400 V 1 CEE 16 A, 5 p, 400 V		6 SCHUKO® 16 A, 230 V	1 RCD 63 A, 4 p, 0.03 A 1 MCB 32 A, 3 p, C 1 MCB 16 A, 3 p, C 6 MCB's 16 A, 1 p, C	For 2 cables up to 5 x 25 mm ²	Pre-fuse max. 63 A InA 52 A RDF 0.65	650 x 225 mm (H x W)	950004

Pre-wired for installation, IP44, enclosure front cover light grey RAL 7035, hinged to the side (except enclosure size 130 x 225 mm and 650 x 112.5 mm). Fusing behind a transparent cover.
[Drawings and dimensions can be found here.](#)

PRODUCT INFORMATION

	<p>CEE receptacles</p> <p>1 CEE 32 A, 5 p, 400 V 2 CEE 16 A, 5 p, 400 V</p>	<p>CEE receptacles</p>	<p>Receptacles NF</p> <p>4 NF 16 A, 2 p+E, 230 V</p>	<p>Fusing</p> <p>1 RCD 63 A, 4 p, 0.03 A 1 MCB 32 A, 3 p+N, C 2 MCB's 16 A, 3 p+N, C 4 MCB's 16 A 1 p+N, C</p>	<p>Connection</p> <p>For 2 cables up to 5 x 25 mm² or for 2 flexible cables up to 5 x 16 mm²</p>	<p>Connection and load values</p> <p>Pre-fuse max. 63 A InA 53 A RDF 0.55</p>	<p>Enclosure size</p> <p>650 x 225 mm (H x W)</p>	<p>Part no.</p> <p>950020</p>
	<p>CEE receptacles</p> <p>2 CEE 32 A, 5 p, 400 V</p>	<p>CEE receptacles</p>	<p>Receptacles NF</p> <p>3 NF 16 A, 2 p+E, 230 V</p>	<p>Fusing</p> <p>1 RCD 63 A, 4 p, 0.03 A 2 MCB's 32 A, 3 p+N, C 3 MCB's 16 A, 1 p+N, C</p>	<p>Connection</p> <p>For 2 cables up to 5 x 25 mm²</p>	<p>Connection and load values</p> <p>Pre-fuse max. 63 A InA 44 A RDF 0.55</p>	<p>Enclosure size</p> <p>520 x 225 mm (H x W)</p>	<p>Part no.</p> <p>940286</p>



Pre-wired for installation, IP44, enclosure front cover light grey RAL 7035, hinged to the side (except enclosure size 130 x 225 mm and 650 x 112.5 mm). Fusing behind a transparent cover.
[Drawings and dimensions can be found here.](#)

PRODUCT INFORMATION

	<p>CEE receptacles</p> <ul style="list-style-type: none"> 1 CEE 63 A, 5 p, 400 V 1 CEE 32 A, 5 p, 400 V 1 CEE 16 A, 5 p, 400 V 	<p>CEE receptacles</p>	<p>Receptacles British standard</p> <p>2 x 13 A, 2 p+E, 240 V</p>	<p>Fusing</p> <ul style="list-style-type: none"> 1 RCD 63 A, 4 p, 0.03 A 1 MCB 32 A, 3 p, C 1 MCB 16 A, 3 p, C 2 MCB's 13 A, 1 p, C 	<p>Connection</p> <p>For 1 cable up to 5 x 25 mm²</p>	<p>Connection and load values</p> <p>Pre-fuse max. 63 A InA 63 A RDF 0.65</p>	<p>Enclosure size (H x W)</p> <p>520 x 225 mm</p>	<p>Part no.</p> <p>941137</p>
	<p>CEE receptacles</p> <ul style="list-style-type: none"> 1 CEE 63 A, 5 p, 400 V 1 CEE 32 A, 5 p, 400 V 1 CEE 16 A, 5 p, 400 V 	<p>CEE receptacles</p>	<p>Receptacles NF</p> <p>4 NF 16 A, 2 p+E, 230 V</p>	<p>Fusing</p> <ul style="list-style-type: none"> 1 RCD 63 A, 4 p, 0.03 A 1 MCB 32 A, 3 p+N, C 1 MCB 16 A, 3 p+N, C 4 MCB's 16 A, 1 p+N, C 	<p>Connection</p> <p>For 2 cables up to 5 x 25 mm²</p>	<p>Connection and load values</p> <p>Pre-fuse max. 63 A InA 63 A RDF 0.5</p>	<p>Enclosure size (H x W)</p> <p>650 x 225 mm</p>	<p>Part no.</p> <p>950022</p>

Pre-wired for installation, IP67, enclosure front cover light grey RAL 7035, hinged to the side (except enclosure size 130 x 225 mm and 650 x 112.5 mm). Fusing behind a transparent cover.
[Drawings and dimensions can be found here.](#)

PRODUCT INFORMATION

	CEE receptacles	CEE receptacles	Receptacles SCHUKO®	Fusing	Connection	Connection and load values	Enclosure size	Part no.
		2 CEE 16 A, 3 p, 230 V			For 2 cables up to 3 x 10 mm ²		130 x 225 mm (H x W)	910355
	CEE receptacles	CEE receptacles	Receptacles SCHUKO®	Fusing	Connection	Connection and load values	Enclosure size	Part no.
	1 CEE 16 A, 5 p, 400 V switched, with mechanical DUO-interlock				For 1 cable up to 5 x 10 mm ²		130 x 225 mm (H x W)	7626



Pre-wired for installation, IP67, enclosure front cover light grey RAL 7035, hinged to the side (except enclosure size 130 x 225 mm and 650 x 112.5 mm). Fusing behind a transparent cover.
[Drawings and dimensions can be found here.](#)

PRODUCT INFORMATION

	<p>CEE receptacles</p> <p>1 CEE 16 A, 5 p, 400 V</p>	<p>CEE receptacles</p>	<p>Receptacles SCHUKO®</p> <p>3 SCHUKO® 16 A, 230 V</p>	<p>Fusing</p> <p>1 RCD 40 A, 4 p, 0.03 A 1 MCB 16 A, 3 p, C 3 MCB's 16 A, 1 p, C</p>	<p>Connection</p> <p>For 2 cables up to 5 x 25 mm²</p>	<p>Connection and load values</p> <p>Pre-fuse max. 100 A InA 30 A RDF 0.95</p>	<p>Enclosure size</p> <p>390 x 225 mm (H x W)</p>	<p>Part no.</p> <p>930022</p>
	<p>CEE receptacles</p> <p>1 CEE 16 A, 4 p, 400 V</p>	<p>CEE receptacles</p>	<p>Receptacles NF</p> <p>3 NF 16 A, 2 p+E, 230 V</p>	<p>Fusing</p> <p>1 RCD 40 A, 4 p, 0.03 A 1 MCB 16 A, 3 p, C 3 MCB's 16 A, 1 p+N, C</p>	<p>Connection</p> <p>For 2 cables up to 5 x 25 mm²</p>	<p>Connection and load values</p> <p>Pre-fuse max. 100 A InA 26 A RDF 0.8</p>	<p>Enclosure size</p> <p>390 x 225 mm (H x W)</p>	<p>Part no.</p> <p>930520</p>

Pre-wired for installation, IP67, enclosure front cover light grey RAL 7035, hinged to the side (except enclosure size 130 x 225 mm and 650 x 112.5 mm). Fusing behind a transparent cover.
[Drawings and dimensions can be found here.](#)

PRODUCT INFORMATION

	CEE receptacles	CEE receptacles	Receptacles SCHUKO®	Fusing	Connection	Connection and load values	Enclosure size	Part no.
	1 CEE 16 A, 5 p, 400 V		4 SCHUKO® 16 A, 230 V		For 1 cable up to 5 x 10 mm ²		650 x 112.5 mm (H x W)	960031
	1 CEE 32 A, 5 p, 400 V 2 CEE 16 A, 4 p, 400 V	3 CEE 16 A, 3 p, 230 V		1 MCB 32 A, 3 p+N, C 1 MCB 16 A, 3 p, C 1 MCB 16 A, 1 p+N, C	For 2 cables up to 5 x 25 mm ²	Pre-fuse max. 100 A InA 45 A RDF 0.45	520 x 225 mm (H x W)	940028



Pre-wired for installation, IP67, enclosure front cover light grey RAL 7035, hinged to the side (except enclosure size 130 x 225 mm and 650 x 112.5 mm). Fusing behind a transparent cover.
[Drawings and dimensions can be found here.](#)

PRODUCT INFORMATION

	CEE receptacles	CEE receptacles	Receptacles SCHUKO®	Fusing	Connection	Connection and load values	Enclosure size (H x W)	Part no.
	2 CEE 32 A, 5 p, 400 V 2 CEE 16 A, 5 p, 400 V switched, with mechanical DUO-interlock			1 RCD 63 A, 4 p, 0.03 A 2 MCB's 32 A, 3 p, C 2 MCB's 16 A, 3 p, C	For 2 cables up to 5 x 25 mm ²	Pre-fuse max. 63 A InA 48 A RDF 0.5	390 x 450 mm	900005
	2 CEE 32 A, 5 p, 400 V switched, with mechanical DUO-interlock 2 CEE 16 A, 5 p, 400 V			1 RCD 63 A, 4 p, 0.03 A 2 MCB's 32 A, 3 p, C 2 MCB's 16 A, 3 p, C	For 1 cable up to 5 x 16 mm ²	Pre-fuse max. 63 A InA 58 A RDF 0.6	650 x 225 mm	900946

Pre-wired for installation, IP67, enclosure front cover light grey RAL 7035, hinged to the side (except enclosure size 130 x 225 mm and 650 x 112.5 mm). Fusing behind a transparent cover.
[Drawings and dimensions can be found here.](#)

PRODUCT INFORMATION

	CEE receptacles	CEE receptacles	Receptacles SCHUKO®	Fusing	Connection	Connection and load values	Enclosure size	Part no.
	3 CEE 32 A, 4 p, 380-440 V, 3 h For reefer container, switched, with mechanical DUO-interlock			3 MCB's 32 A, 3 p, C 1 earth bolt M 10, V2A	For 1 cable up to 5 x 25 mm ²	Pre-fuse max. 100 A InA 58 A RDF 0.6	520 x 225 mm (H x W)	940027
	1 CEE 63 A, 5 p, 400 V 1 CEE 32 A, 5 p, 400 V 1 CEE 16 A, 5 p, 400 V		2 SCHUKO® 16 A, 230 V	1 RCD 63 A, 4 p, 0.03 A 1 MCB 32 A, 3 p, C 1 MCB 16 A, 3 p, C 2 MCB's 16 A, 1 p, C	For 2 cables up to 5 x 25 mm ²	Pre-fuse max. 63 A InA 63 A RDF 0.7	650 x 225 mm (H x W)	950031



Pre-wired for installation, IP67, enclosure front cover light grey RAL 7035, hinged to the side (except enclosure size 130 x 225 mm and 650 x 112.5 mm). Fusing behind a transparent cover.
[Drawings and dimensions can be found here.](#)

PRODUCT INFORMATION

	CEE receptacles	CEE receptacles	Receptacles NF	Fusing	Connection	Connection and load values	Enclosure size (H x W)	Part no.
	1 CEE 63 A, 5 p, 400 V 1 CEE 32 A, 5 p, 400 V 1 CEE 16 A, 5 p, 400 V		2 NF 16 A, 2 p+E, 230 V	1 RCD 63 A, 4 p, 0.03 A 1 MCB 32 A, 3 p+N, C 1 MCB 16 A, 3 p+N, C 2 MCB's 16 A, 1 p+N, C	For 2 cables up to 5 x 25 mm ²	Pre-fuse max. 63 A InA 63 A RDF 0.5	650 x 225 mm (H x W)	950033



 Highly resistant to chemicals made of AMELAN, pre-wired for installation, IP44, enclosure front cover grey RAL 7000, hinged to the side (except enclosure size 130 x 225 mm and 650 x 112.5 mm). Fusing behind a transparent cover. [Drawings and dimensions can be found here.](#)

PRODUCT INFORMATION

	CEE receptacles	CEE receptacles	Receptacles SCHUKO®	Fusing	Connection	Connection and load values	Enclosure size	Part no.
	CEE receptacles	CEE receptacles	Receptacles SCHUKO®	Fusing	Connection	Connection and load values	Enclosure size	Part no.
	1 CEE 16 A, 5 p, 400 V		2 SCHUKO® 16 A, 230 V		For 1 cable up to 5 x 10 mm ²		130 x 225 mm (H x W)	910020
	1 CEE 63 A, 5 p, 400 V 1 CEE 32 A, 5 p, 400 V 1 CEE 16 A, 5 p, 400 V		4 SCHUKO® 16 A, 230 V	1 RCD 63 A, 4 p, 0.03 A 1 MCB 32 A, 3 p, C 1 MCB 16 A, 3 p, C 4 MCB's 16 A, 1 p, C	For 2 cables up to 5 x 25 mm ²	Pre-fuse max. 63 A InA 63 A RDF 0.65	650 x 225 mm (H x W)	950041





 Highly resistant to chemicals made of AMELAN, pre-wired for installation, IP67, enclosure front cover grey RAL 7000, hinged to the side (except enclosure size 130 x 225 mm and 650 x 112.5 mm). Fusing behind a transparent cover. [Drawings and dimensions can be found here.](#)

PRODUCT INFORMATION

	CEE receptacles	CEE receptacles	Receptacles SCHUKO®	Fusing	Connection	Connection and load values	Enclosure size (H x W)	Part no.
	1 CEE 16 A, 5 p, 400 V	2 CEE 16 A, 3 p, 230 V	3 SCHUKO® 16 A, 230 V	1 RCD 25 A, 2 p, 0.03 A	For 1 cable up to 3 x 10 mm ²	Pre-fuse max. 16 A InA 25 A RDF 1	260 x 225 mm	920821
								

 Highly resistant to chemicals made of AMELAN, pre-wired for installation, IP67, enclosure front cover grey RAL 7000, hinged to the side (except enclosure size 130 x 225 mm and 650 x 112.5 mm). Fusing behind a transparent cover. [Drawings and dimensions can be found here.](#)

PRODUCT INFORMATION

	CEE receptacles	CEE receptacles	Receptacles SCHUKO®	Fusing	Connection	Connection and load values	Enclosure size	Part no.
	1 CEE 32 A, 5 p, 400 V		3 SCHUKO® 16 A, 230 V	1 RCD 40 A, 4 p, 0.03 A 1 MCB 32 A, 3 p, C 3 MCB's 16 A, 1 p, C	For 2 cables up to 5 x 25 mm ²	Pre-fuse max. 40 A InA 36 A RDF 0.75	390 x 225 mm (H x W)	930028
								
	1 CEE 32 A, 5 p, 400 V 1 CEE 16 A, 5 p, 400 V		2 SCHUKO® 16 A, 230 V	1 RCD 63 A, 4 p, 0.03 A 1 MCB 32 A, 3 p, C 1 MCB 16 A, 3 p, C 2 MCB's 16 A, 1 p, C	For 2 cables up to 5 x 25 mm ²	Pre-fuse max. 100 A InA 44.8 A RDF 0.7	520 x 225 mm (H x W)	940016
								

Accessories for AMAXX receptacle combinations.

	<p>Column</p> <p>made from stainless steel (material 1.4301) surface: stainless steel, bright finish (basic column for the shields 15682 and 15683)</p> <p>height approx. 130 mm</p> <p>Part no. 15530</p>		<p>Weather shield</p> <p>made from stainless steel (material 1.4301), with side blinds, cover can be removed from the back, for wall mounting or on a column 15530</p> <p>dimensions (H x W x D): 496.5 x 254 x 250 mm</p> <p>surface: bright finish</p> <p>Suitable for AMAXX combinations with 2 or 3 segments</p> <p>Part no. 15682</p>
	<p>2 x Tube clips made of stainless steel</p> <p>22986: diameter 70-90 mm 22987: diameter 90-110 mm 22988: diameter 110-130 mm</p>		<p>Weather shield</p> <p>made from stainless steel (material 1.4301), with side blinds, cover can be removed from the back, for wall mounting or on a column 15530</p> <p>dimensions (H x W x D): 758 x 254 x 280 mm</p> <p>surface: bright finish</p> <p>Suitable for AMAXX combinations with 4 or 5 segments</p> <p>Part no. 15683</p>

Accessories for AMAXX receptacle combinations.



AMAXX standard cable glands

deep black RAL 9005

M 20 - for cable from 6-13 mm

IP44: **Part no. 990607**

IP67: **Part no. 990611**

M 25 - for cable from 9-17 mm

IP44: **Part no. 990610**

M 32 - for cable from 13-21 mm

IP44: **Part no. 990608**

IP67: **Part no. 990612**

M 40 - for cable from 14-28 mm

IP67: **Part no. 990609**



AMAXX screw set

consisting of 4 screws 6 x 70 mm

Pozidrive size 3, steel galvanized and 4 dowels 8 x 50 mm, for concrete, porous concrete, solid brick, perforated brick

Part no. 990606



AMAXX attachment set

for lateral installation of AMAXX s combinations, for mounting either on the left or right hand side (set of 2 for 1 combination)

Part no. 990620

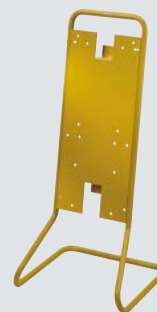

AMAXX support/carrier frame

signal yellow RAL 1003, suitable for AMAXX receptacle combinations with the sizes:
260 x 225 mm, 390 x 225 mm and 520 x 225 mm for wall mounting in protection type IP67 or as mobile combinations with carrying handle and with feeder cable in protection type IP44 and IP67

Part no. 15696

Accessories for AMAXX receptacle combinations.



AMAXX membrane cable glands

deep black RAL 9005,
incl. blanking plug

M 25 - for cable from 9-17 mm
Part no. 990623

M 32 - for cable from 13-21 mm
Part no. 990625





M 40 - for cable from 16-28 mm
Part no. 990627

Selection chart for membrane cable glands			
AMAXX receptacle combination	Standard cable entries	Recommendation of usage membrane cable gland*	
with 1 segment Enclosure: 130 x 225 mm (H x W)	top: 2 x M 25 2 x M 20 bottom: 2 x M 25 2 x M 20	1 x M 25	alternative: 1 x M 20
with 2 segments Enclosure: 230 x 225 mm (H x W)	top: 2 x M 32 2 x M 20 bottom: 2 x M 32 2 x M 20	1 x M 32	alternative: 2 x M 20
with 3 segments Enclosure: 390 x 225 mm (H x W)	top: 2 x M 40 2 x M 20 bottom: 2 x M 40 2 x M 20	1 x M 40	alternative: 2 x M 20
with 4 segments Enclosure: 520 x 225 mm (H x W)	top: 2 x M 40 2 x M 20 bottom: 2 x M 40 2 x M 20	1 x M 40 und 1 x M 20	alternative: 3 x M 20
with 5 segments Enclosure: 650 x 225 mm (H x W)	top: 2 x M 40 2 x M 20 bottom: 2 x M 40 2 x M 20	1 x M 40 und 2 x M 20	alternative: 4 x M 20

*** At least required for the following ambient conditions:**
Reduction of the ambient temperature by 45 °C through 10-minutes of heavy rain (enclosure, e.g heated to 60 °C through sunlight, subsequent cloudburst with water temperature of 15 °C).
If temperature differentials are greater/less, accordingly more or fewer membrane cable glands must be used.

Pre-wired for installation, IP44, enclosure front cover light grey, yellow or silver, hinged to the side. Fusing behind a transparent cover. With suspension eyes on top, grip hooks on the bottom and chain set provided.
 The receptacle combinations can be ordered in light grey RAL 7035, yellow RAL 1021 or silver RAL 9006. Other combinations than those shown are available on request. To order in yellow or silver, please add the appropriate colour code to the order number (yellow = GE, silver = SI). [Drawings and dimensions can be found here.](#)





PRODUCT INFORMATION

	CEE receptacles	CEE receptacles	Receptacles SCHUKO®	Fusing	Connection	Connection and load values	Enclosure size	Part no.
 	2 CEE 16 A, 5 p, 400 V		4 SCHUKO® 16 A, 230 V	1 RCD 40 A, 4 p, 0.03 A 2 MCB's 16 A, 3 p, C 4 MCB's 16 A, 1 p, C	For 1 cable up to 5 x 10 mm ²	Pre-fuse max. 40 A I _{nA} 40 A RDF 0.7	260 x 225 mm (H x W)	970004GE
 	1 CEE 32 A, 5 p, 400 V 1 CEE 16 A, 5 p, 400 V		3 SCHUKO® 16 A, 230 V	1 RCD 40 A, 4 p, 0.03 A 1 MCB 16 A, 3 p, C 3 MCB's 16 A, 1 p, C	For 1 cable up to 5 x 10 mm ²	Pre-fuse max. 32 A I _{nA} 32 A RDF 1	260 x 225 mm (H x W)	970002

Pre-wired for installation, IP44, enclosure front cover light grey, yellow or silver, hinged to the side. Fusing behind a transparent cover. With suspension eyes on top, grip hooks on the bottom and chain set provided.

The receptacle combinations can be ordered in light grey RAL 7035, yellow RAL 1021 or silver RAL 9006. Other combinations than those shown are available on request. To order in yellow or silver, please add the appropriate colour code to the order number (yellow = GE, silver = SI). [Drawings and dimensions can be found here.](#)

PRODUCT INFORMATION

	CEE receptacles	Data port sockets	Receptacles SCHUKO®	Fusing	Connection	Connection and load values	Enclosure size	Part no.
 	1 CEE 32 A, 5 p, 400 V 1 CEE 16 A, 5 p, 400 V	1 Cepex RJ45, 2 fold Cat.6	3 SCHUKO® 16 A, 230 V	1 RCD 40 A, 4 p, 0.03 A 1 MCB 16 A, 3 p, C 3 MCB's 16 A, 1 p, C	For 1 cable up to 5 x 10 mm ²	Pre-fuse max. 32 A InA 32 A RDF 1	260 x 225 mm (H x W)	970005
 	1 CEE 32 A, 5 p, 400 V 1 CEE 16 A, 5 p, 400 V	CEE receptacles	Receptacles SCHUKO®	1 RCD 40 A, 4 p, 0.03 A 1 MCB 32 A, 3 p, C 1 MCB 16 A, 3 p, C 4 MCB's 16 A, 1 p, C	For 1 cable up to 5 x 10 mm ²	Pre-fuse max. 40 A InA 40 A RDF 0.75	260 x 225 mm (H x W)	970001GE



Pneumatic connection

for suspendable AMAXX

for tube NW 9 mm

Part no. 997001

for tube NW 13 mm

Part no. 997000





Set of chains

are provided with each suspendable AMAXX receptacle combination



Pre-wired for installation, IP44 or IP67, enclosure front cover light grey RAL 7035, hinged to the side. Fusing behind a transparent cover.
[Drawings and dimensions can be found here.](#)

PRODUCT INFORMATION

	CEE receptacles	CEE receptacles	Receptacles SCHUKO®	Fusing	Connection	Connection and load values	Enclosure size	Part no.
	CEE receptacles	CEE receptacles	Receptacles NF	Fusing	Connection	Connection and load values	Enclosure size	Part no.
			3 SCHUKO® 16 A, 230 V		1,5 m H07RN-F3G1,5 with plug SCHUKO® 16 A, 230 V		130 x 225 mm (H x B)	910031
			5 NF 16 A, 2 p+E, 230 V	1 RCD 25 A, 2 p, 0.03 A	2 m H07RN-F3G2.5 with NF-plug 16 A, 2 p+E, 230 V	Pre-fuse max. 16 A InA 16 A RDF 1	260 x 225 mm (H x W)	920046

Pre-wired for installation, IP44 or IP67, enclosure front cover light grey RAL 7035, hinged to the side. Fusing behind a transparent cover.
[Drawings and dimensions can be found here.](#)

PRODUCT INFORMATION

	<p>CEE receptacles</p>	<p>CEE receptacles</p> <p>3 CEE 16 A, 3 p, 230 V, switched, with mechanical DUO-interlock</p>	<p>Receptacles SCHUKO®</p>	<p>Fusing</p> <p>1 RCD 40 A, 4 p, 0.03 A 1 MCB 16 A, 3 p+N, C</p>	<p>Connection</p> <p>4 m H07RN-F5G2.5 with CEE-plug 16 A, 5 p, 400 V</p>	<p>Connection and load values</p> <p>Pre-fuse max. 16 A I_{nA} 16 A RDF 1</p>	<p>Enclosure size</p> <p>520 x 225 mm (H x W)</p>	<p>Part no.</p> <p>940030</p>
	<p>CEE receptacles</p> <p>1 CEE 32 A, 5 p, 400 V 1 CEE 16 A, 5 p, 400 V</p>	<p>CEE receptacles</p>	<p>Receptacles British standard</p> <p>3 x 13 A, 2 p+E, 240 V</p>	<p>Fusing</p> <p>1 RCD 40 A, 4 p, 0.03 A 1 MCB 16 A, 3 p, C 3 MCB's 13 A, 1 p, C</p>	<p>Connection</p> <p>2 m H07RN-F5G4 with CEE-plug 32 A, 5 p, 400 V</p>	<p>Connection and load values</p> <p>Pre-fuse max. 32 A I_{nA} 32 A RDF 1</p>	<p>Enclosure size</p> <p>390 x 225 mm (H x W)</p>	<p>Part no.</p> <p>931237</p>

AirKRAFT und 3KRAFT

The Team for electrical power. Data. Compressed air.

For ceiling and floor.

You need electrical power, compressed air, data? Safe and flexible?

Go for AirKRAFT or 3KRAFT. Characteristic for both: Suspended from the ceiling, attached to the wall, or portable with a supply cable, also available in signal yellow, red or silver. The choice is yours!

Up to four receptacles plus compressed air. Pre-wired for installation or operation, with a supply cable and plug.



AirKRAFT und 3KRAFT

Drawings and dimensions.

AirKRAFT

DIN rail / fusing for 4 modules beneath transparent operating lid.

Cable entry: at the top: 1 x M 32, 1 x M 25, 2 x M 20 (blind, to be cut out), 1 x cut out for quick pneumatic connection; from the side (for wall fixing or portable version): 1 x M 25 (blind, to be cut out).

3KRAFT

Cable entry: at the top: 1 x M 32, 1 x M 25, 2 x M 20 (blind, to be cut out), 1 x cut out for quick pneumatic connection; from the side (for wall fixing or portable version): 1 x M 25 (blind, to be cut out).

Pre-wired for installation, IP20 or IP44. Fusing behind a transparent cover.
Colours: Back box in black, cover available in red (RO), yellow (GE) or silver (SI). Other combinations than those shown are available on request.
[Drawings and dimensions can be found here.](#)

PRODUCT INFORMATION

	Fitted with	Fusing	Connection	Connection and load values	Protection type	Part no.
	1 CEE 16 A, 5 p, 400 V 3 SCHUKO® 16 A, 230 V		For 1 cable up to 5 x 10 mm ²		IP44	94550SI
	2 CEE 16 A, 5 p, 400 V 2 SCHUKO® 16 A, 230 V		For 1 cable up to 5 x 10 mm ²		IP44	94552RO

Pre-wired for installation, IP20 or IP44. Fusing behind a transparent cover.
Colours: Back box in black, cover available in red (RO), yellow (GE) or silver (SI). Other combinations than those shown are available on request.
[Drawings and dimensions can be found here.](#)

PRODUCT INFORMATION

	Fitted with	Fusing	Connection	Connection and load values	Protection type	Part no.
	2 CEE 16 A, 5 p, 400 V 2 SCHUKO® 16 A, 230 V	1 RCD 40 A, 4 p, 0.03 A	For 1 cable up to 5 x 10 mm ²	Pre-fuse max. 16 A InA 16 A	IP44	94553GE

Pre-wired for installation, IP20 or IP44. Fusing behind a transparent cover.
Colours: Back box in black, cover available in red (RO), yellow (GE) or silver (SI). Other combinations than those shown are available on request.
[Drawings and dimensions can be found here.](#)

PRODUCT INFORMATION

	Fitted with	Fusing	Connection	Connection and load values	Protection type	Part no.
	3 SCHUKO® 16 A, 230 V		For 1 cable up to 3 x 6 mm ²		IP44	94351GE
	2 SCHUKO® 16 A, 230 V 1 RJ45 double data port cat.6, 8/8		For 1 cable up to 3 x 6 mm ²		IP20	94354SI

Pre-wired for installation, IP20 or IP44. Fusing behind a transparent cover.
Colours: Back box in black, cover available in red (RO), yellow (GE) or silver (SI). Other combinations than those shown are available on request.
[Drawings and dimensions can be found here.](#)

PRODUCT INFORMATION

	Fitted with	Fusing	Connection	Connection and load values	Protection type	Part no.
	1 CEE 16 A, 5 p, 400 V 1 SCHUKO® 16 A, 230 V 1 RJ45 double data port cat.6, 8/8		For 1 cable up to 5 x 10 mm ²		IP20	94355GE

DELTA-BOX the classic unit.

With cable grip. Each DELTA-BOX comes with a suspension bracket.
Available in IP44, IP67 and IP68.



Receptacle strips the versatile units.

Suspendable, portable or for wall mounting. Pre-wired for installation.
With cable gland. Available in IP44.



DELTA-BOX und Receptacle strips

Drawings and dimensions.

DELTA-BOX

Cable entry: 1 x with gland
diameter, Ø 17 mm or 27 mm

Cable entry: 1 x with gland
diameter, Ø 17 mm or 27 mm

Receptacle strip

Enclosure size: 401 x 97 mm
Cable entry: 1 x M 20 plugged at the top,
1 x M 20 with gland at the bottom

Pre-wired for installation, IP44 / 67. With cable grip and installed hanging hook. Other combinations on request.
[Drawings and dimensions can be found here.](#)

PRODUCT INFORMATION

	<p>Fitted with</p> <p>3 CEE 16 A, 5 p, 400 V</p>	<p>Fusing</p>	<p>Connection</p> <p>For 1 cable up to 5 x 6 mm²</p>	<p>Connection and load values</p>	<p>Protection type</p> <p>IP44</p>	<p>Part no.</p> <p>92917</p>
	<p>Fitted with</p> <p>3 CEE 32 A, 5 p, 400 V</p>	<p>Fusing</p>	<p>Connection</p> <p>For 1 cable up to 5 x 6 mm²</p>	<p>Connection and load values</p>	<p>Protection type</p> <p>IP44</p>	<p>Part no.</p> <p>90839</p>

Pre-wired for installation, IP44 / 67. With cable grip and installed hanging hook. Other combinations on request.
[Drawings and dimensions can be found here.](#)

PRODUCT INFORMATION

	Fitted with	Fusing	Connection	Connection and load values	Protection type	Part no.
	1 CEE 16 A, 5 p, 400 V 3 SCHUKO® 16 A, 230 V		For 1 cable up to 5 x 6 mm ²		IP44	92658
	2 CEE 16 A, 5 p, 400 V 1 CEE 16 A, 3 p, 230 V		For 1 cable up to 5 x 6 mm ²		IP67	92893

Pre-wired for installation, IP44 / 67. With cable grip and installed hanging hook. Other combinations on request.
[Drawings and dimensions can be found here.](#)

PRODUCT INFORMATION

	Fitted with	Fusing	Connection	Connection and load values	Protection type	Part no.
	3 CEE 16 A, 3 p, 110 V		For 1 cable up to 3 x 6 mm ²		IP44	96227
	Fitted with	Fusing	Connection	Connection and load values	Protection type	Part no.
	3 CEE 16 A, 3 p, 230 V		For 1 cable up to 3 x 6 mm ²		IP44	96489

Pre-wired for installation, IP44 / 67. With cable grip and installed hanging hook. Other combinations on request.
[Drawings and dimensions can be found here.](#)

PRODUCT INFORMATION

	Fitted with	Fusing	Connection	Connection and load values	Protection type	Part no.
	3 CEE 16 A, 5 p, 400 V		For 1 cable up to 5 x 6 mm ²		IP44	96705
	Fitted with	Fusing	Connection	Connection and load values	Protection type	Part no.
	2 CEE 16 A, 5 p, 400 V 1 SCHUKO® 16 A, 230 V		For 1 cable up to 5 x 6 mm ²		IP44	96703

EverGUM

Flexible safety.

With the EverGUM range MENNEKES provide a solid rubber alternative to enclosures in plastics and sheet steel. This is an alternative which is suitable for the most diverse environments, especially when there is likely to be exposure to rough handling or aggressive cleaning agents. These products can also be supplied to conform to the standards of other European countries.

The outstanding advantages:

- Resistant to weather and ageing
- High dimensional stability and precision
- Good resistance to acids and alkalis
- High dielectric strength and creep resistance

The allround power-packages for mobile use in industry, craft and trade. They can accept quite a knock – neither their design nor their function will be impaired. Additional benefit: they are stackable which allows space-saving storage.

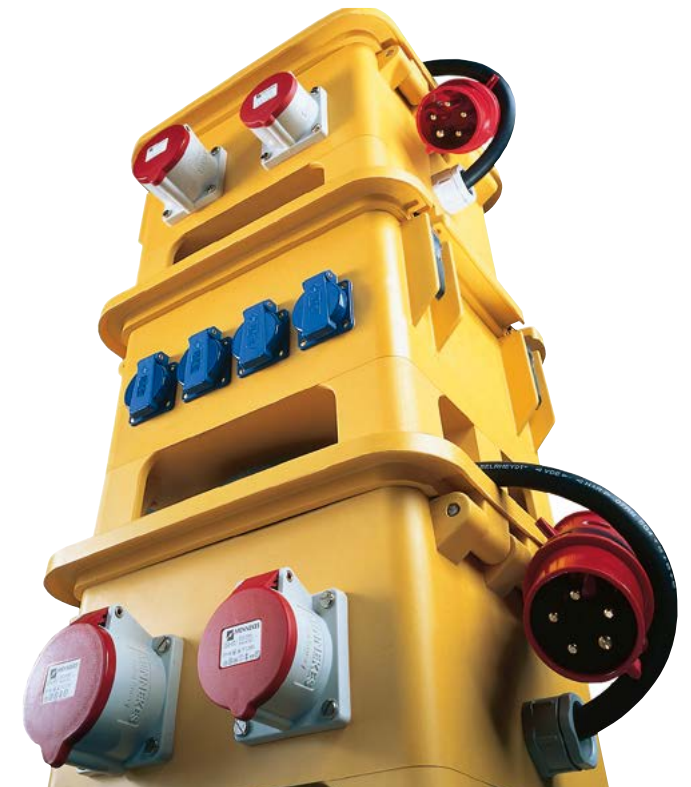

EverGUM

Flexible safety.

Tested safety, EverGUM details.

The closed lower side of the enclosure with a ground clearance of 77 mm prevents ingress of water. The panel mounted receptacles can be replaced from outside. Hinged cover provided with stainless steel quick release clips. MCB's and in RCD's are immediately accessible after opening the lid. All energised parts even with the lid open are covered so that they are contact safe – in accordance with BGV A3. Screw or padlock offers additional safety.

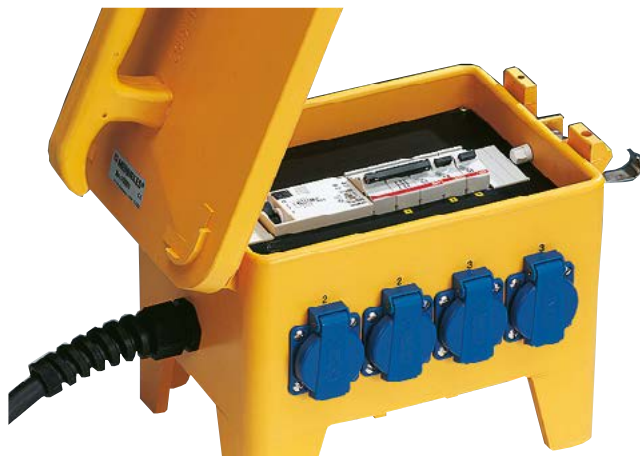

 Search



 You can find more information on our website

Receptacle strip EverGUM.

Window size for six or eight modules for vertical installation.



 Index

EverGUM

Drawings and dimensions.

Enclosure size: 380 x 320 mm

Cable entry: 1 x M 40 at the top **with threaded cable gland** and 1 x M 40 plugged at the top
2 x M 40 plugged at the bottom Space for 16 modules.

Dimensions: 380 x 230 mm

Cable entry: 1 x M 40 at the top **with threaded cable gland** and 1 x M 40 plugged at the top
2 x M 40 plugged at the bottom Space for 12 modules.

Enclosure size: 445 x 135 mm

EverGUM

Drawings and dimensions.

Enclosure size: 360 x 340 x 330 mm



Enclosure size: 300 x 230 x 287.5 mm

Pre-wired for installation, IP44. Fusing behind a transparent cover.

Colour: signal yellow. Other variations with CEE receptacles 3, 4 or 5 pole and with grounding-type receptacles of French/Belgian, British, Swiss and US-standards on request.



[Drawings and dimensions can be found here.](#)

PRODUCT INFORMATION

	Fitted with	Fusing	Connection	Connection and load values	Protection type	Part no.
	1 CEE 32 A, 5 p, 400 V 1 CEE 16 A, 5 p, 400 V 3 SCHUKO® 16 A, 230 V	1 MCB 32 A, 3 p, C 2 MCB's 16 A, 3 p, C 3 MCB's 16 A, 1 p, B	for 2 cables up to 5 x 25 mm ²	Pre-fuse max. 100 A InA 48 A RDF 0.75	IP44	70007
	1 CEE 63 A, 5 p, 400 V 1 CEE 32 A, 5 p, 400 V 1 CEE 16 A, 5 p, 400 V 4 SCHUKO® 16 A, 230 V	1 MCB 63 A, 3 p, C 1 MCB 32 A, 3 p, C 1 MCB 16 A, 3 p, C 2 MCB's 16 A, 1 p, B	for 2 cables up to 5 x 25 mm ²	Pre-fuse max. 63 A InA 63 A RDF 1	IP44	71062

Pre-wired for installation, IP44. Fusing behind a transparent cover.
Colour: signal yellow. Other variations with CEE receptacles 3, 4 or 5 pole and with grounding-type receptacles of French/Belgian, British, Swiss and US-standards on request.
[Drawings and dimensions can be found here.](#)

PRODUCT INFORMATION



	Fitted with	Fusing	Connection	Connection and load values	Protection type	Part no.
	3 CEE 16 A, 5 p, 400 V		2 m H07RN-F5G2.5 with CEE-plug 16 A, 5 p, 400 V		IP44	70029
	1 CEE 16 A, 5 p, 400 V 2 SCHUKO® 16 A, 230 V	1 RCD 40 A, 4 p, 0.03 A 2 MCB's 16 A, 1 p, B	2 m H07RN-F5G2.5 with CEE-plug 16 A, 5 p, 400 V	Pre-fuse max. 16 A InA 16 A RDF 0.95	IP44	70033

Pre-wired for installation, IP44. Fusing behind a transparent cover.

Colour: signal yellow. Other variations with CEE receptacles 3, 4 or 5 pole and with grounding-type receptacles of French/Belgian, British, Swiss and US-standards on request.

[Drawings and dimensions can be found here.](#)

PRODUCT INFORMATION

	Fitted with	Fusing	Connection	Connection and load values	Protection type	Part no.
	2 CEE 16 A, 5 p, 400 V 4 SCHUKO® 16 A, 230 V	1 RCD 40 A, 4 p, 0.03 A	with inlet 16 A, 5 p, 400 V	Pre-fuse max. 16 A InA 16 A RDF 1	IP44	70350
	1 CEE 32 A, 5 p, 400 V 1 CEE 16 A, 5 p, 400 V 4 SCHUKO® 16 A, 230 V	1 RCD 40 A, 4 p, 0.03 A 1 MCB 16 A, 3 p, C 2 MCB's 16 A, 1 p, B	2 m H07RN-F5G4 with CEE-plug 32 A, 5 p, 400 V	Pre-fuse max. 32 A InA 32 A RDF 0.95	IP44	70351

Pre-wired for installation, IP44. Fusing behind a transparent cover.
Colour: signal yellow. Other variations with CEE receptacles 3, 4 or 5 pole and with grounding-type receptacles of French/Belgian, British, Swiss and US-standards on request.
[Drawings and dimensions can be found here.](#)

PRODUCT INFORMATION

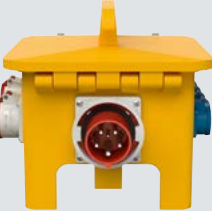
	Fitted with	Fusing	Connection	Connection and load values	Protection type	Part no.
	1 CEE 63 A, 5 p, 400 V 1 CEE 32 A, 5 p, 400 V 1 CEE 16 A, 5 p, 400 V 4 SCHUKO® 16 A, 230 V	1 RCD 63 A, 4 p, 0.03 A 1 MCB 32 A, 3 p, C 1 MCB 16 A, 3 p, C 2 MCB's 16 A, 1 p, B	3 m H07RN-F5G10 with CEE-plug 63 A, 5 p, 400 V	Pre-fuse max. 63 A InA 63 A RDF 0.6	IP44	70025
	1 CEE 63 A, 5 p, 400 V 1 CEE 32 A, 5 p, 400 V 1 CEE 16 A, 5 p, 400 V 4 SCHUKO® 16 A, 230 V	1 RCD 63 A, 4 p, 0.03 A 1 MCB 32 A, 3 p, C 1 MCB 16 A, 3 p, C 2 MCB's 16 A, 1 p, B	with inlet 63 A, 5 p, 400 V	Pre-fuse max. 63 A InA 63 A RDF 0.5	IP44	70049

EverBOX

Mobile distributor for events, fairs, emergency services, heavy industries, markets and funfairs.

The new mobile receptacle combinations are available in a variety of assembly fittings. The robust, stackable insulating enclosure are ideally suited for indoor and outdoor use.

Product details

- Robust, watertight insulating enclosure IP67, deep black (RAL 9005)
- Acc. to IEC 61439
- Heat resistant -25 °C up to +40 °C
- Resistant to ageing and weather
- Stackable
- Protection of receptacles and built-in appliances by stable enclosure frame
- Easy handling with integrated handles
- Flexible fitting options up to 125 A
- Protection against condensation in IP67
- Fitted with receptacles of protection type IP44 or IP67
- Fusing behind a transparent cover
- Pre-wired for installation

For customized solutions which are especially made for your applicaton, please contact us!



EverBOX

Drawings and dimensions.

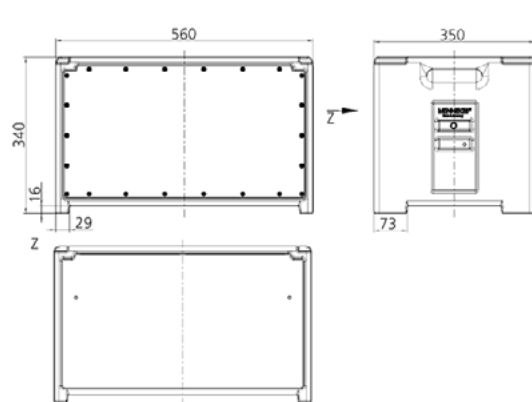



Drawing
5 MB 70

Dim. in mm



Pre-wired for installation, IP44 or IP67. Insulating enclosure IP67, deep black (RAL 9005), fusing behind a transparent cover. Other combinations on request.
[Drawings and dimensions can be found here.](#)

PRODUCT INFORMATION

	<p>CEE receptacles</p> <p>1 CEE 32 A, 5 p, 400 V 2 CEE 16 A, 5 p, 400 V</p>	<p>CEE receptacles</p>	<p>Receptacles SCHUKO®</p> <p>6 SCHUKO® 16 A, 230 V</p>	<p>Fusing</p> <p>1 RCD 63 A, 4 p, 0.03 A 1 MCB 32 A, 3 p, C 2 MCB's 16 A, 3 p, C 6 MCB's 16 A, 1 p, C</p>	<p>Connection</p> <p>2 m H07RN-F5G10 with CEE-plug 63 A, 5 p, 400 V</p>	<p>Connection and load values</p> <p>Pre-fuse max. 63 A InA 63 A RDF 0.75</p>	<p>Enclosure size</p> <p>560 x 350 x 340 mm (H x W x D)</p>	<p>Protection type</p> <p>IP67</p>	<p>Part no.</p> <p>9500719</p>
	<p>CEE receptacles</p> <p>1 CEE 32 A, 5 p, 400 V 1 CEE 16 A, 5 p, 400 V</p>	<p>CEE receptacles</p>	<p>Receptacles SCHUKO®</p> <p>12 SCHUKO® 16 A, 230 V</p>	<p>Fusing</p> <p>1 RCD 40 A, 4 p, 0.03 A 1 MCB 16 A, 3 p, C, 10 kA 12 MCB's 16 A, 1 p, C, 10 kA 3 Phase control lights green</p>	<p>Connection</p> <p>2 m H07RN-F5G6 with CEE-plug 32 A, 5 p, 400 V</p>	<p>Connection and load values</p> <p>Pre-fuse max. 32 A InA 32 A RDF 1</p>	<p>Enclosure size</p> <p>560 x 350 x 340 mm (H x W x D)</p>	<p>Protection type</p> <p>IP44</p>	<p>Part no.</p> <p>9500722</p>

Pre-wired for installation, IP44 or IP67. Insulating enclosure IP67, deep black (RAL 9005), fusing behind a transparent cover. Other combinations on request.
[Drawings and dimensions can be found here.](#)

PRODUCT INFORMATION

	<p>CEE receptacles</p> <p>2 CEE 32 A, 5 p, 400 V 4 CEE 16 A, 5 p, 400 V</p>	<p>CEE receptacles</p>	<p>Receptacles SCHUKO®</p> <p>5 SCHUKO® 16 A, 230 V</p>	<p>Fusing</p> <p>2 RCD's 63 A, 4 p, 0.03 A 2 MCB's 32 A, 3 p, C 4 MCB's 16 A, 3 p, C 5 MCB's 16 A, 1 p, C</p>	<p>Connection</p> <p>2 m H07RN-F5G10 with CEE-plug 63 A, 5 p, 400 V</p>	<p>Connection and load values</p> <p>Pre-fuse max. 63 A InA 63 A RDF 0.75</p>	<p>Enclosure size</p> <p>560 x 350 x 340 mm (H x W x D)</p>	<p>Protection type</p> <p>IP44</p>	<p>Part no.</p> <p>9500706</p>
	<p>CEE receptacles</p> <p>1 CEE 63 A, 5 p, 400 V 2 CEE 32 A, 5 p, 400 V 2 CEE 16 A, 5 p, 400 V</p>	<p>CEE receptacles</p>	<p>Receptacles SCHUKO®</p> <p>9 SCHUKO® 16 A, 230 V</p>	<p>Fusing</p> <p>1 RCD 63 A, 4 p, 0.03 A 2 MCB's 32 A, 3 p, C 2 MCB's 16 A, 3 p, C 9 MCB's 16 A, 1 p, C</p>	<p>Connection</p> <p>2 m H07RN-F5G10 with CEE-plug 63 A, 5 p, 400 V</p>	<p>Connection and load values</p> <p>Pre-fuse max. 63 A InA 63 A RDF 0.7</p>	<p>Enclosure size</p> <p>560 x 350 x 340 mm (H x W x D)</p>	<p>Protection type</p> <p>IP44</p>	<p>Part no.</p> <p>9500748</p>

Pre-wired for installation, IP44 or IP67. Insulating enclosure IP67, deep black (RAL 9005), fusing behind a transparent cover. Other combinations on request.
[Drawings and dimensions can be found here.](#)

PRODUCT INFORMATION

	CEE receptacles	CEE receptacles	Receptacles SCHUKO®	Fusing	Connection	Connection and load values	Enclosure size	Protection type	Part no.
	1 CEE 125 A, 5 p, 400 V 1 CEE 63 A, 5 p, 400 V 2 CEE 32 A, 5 p, 400 V 2 CEE 16 A, 5 p, 400 V		3 SCHUKO® 16 A, 230 V	2 RCD's 63 A, 4 p, 0.03 A 2 MCB's 63 A, 3 p, C 2 MCB's 32 A, 3 p, C 2 MCB's 16 A, 3 p, C 3 MCB's 16 A, 1 p, C	2 m H07RN-F5G25 with CEE-plug 125 A, 5 p, 400 V	Pre-fuse max. 125 A InA 125 A RDF 0.43	560 x 350 x 340 mm (H x W x D)	IP44	9500417

CombiTOWER

Drawings and dimensions.

CombiTOWER



CombiTOWER from stainless steel (material 1.4301), material 1.4571 on request.
[Drawings and dimensions can be found here.](#)

	Title	Fitted with	Enclosure size	Part no.
	CombiTOWER	with removable cover, painted signal yellow (RAL 1003) or bright finish.	<p>Part no. for AMAXX enclosures 260 x 225 mm, 390 x 225 mm and 520 x 225 mm</p>	1043 x 254.5 x 250 mm (H x W x D)
	Title	Fitted with	Enclosure size	Part no.
	CombiTOWER	with lockable door and removable cover, painted signal yellow (RAL 1003) or bright finish	<p>Part no. for AMAXX enclosures 260 x 225 mm, 390 x 225 mm and 520 x 225 mm</p>	1043 x 254 x 415 mm (H x W x D)

CombiTOWER from stainless steel (material 1.4301), material 1.4571 on request.
[Drawings and dimensions can be found here.](#)

	Title	Fitted with	Enclosure size	Part no.
	CombiTOWER	with removable cover, painted signal yellow (RAL 1003) or bright finish. Part no. for AMAXX enclosures 650 x 225 mm	1043 x 254.5 x 250 mm (H x W x D)	15739 yellow 15738 bright finish
	Title	Fitted with	Enclosure size	Part no.
	CombiTOWER	with lockable door and removable cover, painted signal yellow (RAL 1003) or bright finish Part no. for AMAXX enclosures 650 x 225 mm	1043 x 254 x 415 mm (H x W x D)	15741 yellow 15740 bright finish

SCHUKO®

Plugs and sockets for harsh conditions.

SCHUKO® by MENNEKES with the hammer symbol.

Acc. to VDE 0105 part 115. Made of high-grade plastic. Acc. to DIN VDE 0620-1 / -2 for harsh conditions. Application amongst others in agriculture or at construction sites. Resistant against oil, grease and fuel. Long lasting due to high resistance against abrasion and breaking strenght. Durable due to resistance against embrittlement.



Panel mounted receptacles SCHUKO® with front gasket for portable units.

The attachment receptacles SCHUKO® with sealing collars, from MENNEKES comply with the requirements in the new standard, DIN VDE 0620-1. With the hinged lid closed, they meet the requirements for the IP54 degree of protection in every position. Even with the compatible IP44 plug, plugged-in, the IP44 protection rating is ensured regardless of the operating position.

SCHUKO®

Plugs and sockets for harsh conditions.

SCHUKO®. Pressure watertight.

Whether fixed or mobile: in the event of flooding or water jets, pressure watertight plugs and receptacles are the first choice. Protection type IP68.



Product advantages:

- retention of the installation dimensions and conditions
- conversion without problems
- flange sealing made of thermoplastic elastomer (TPE)
- captive due to two components technology
- safe against accidental actuation with a finger or the back of the hand according to IEC 60529
- optionally screw or plug-in terminals
- with hammer symbol for toughest conditions
- also available with flange dimensions 75 x 75 mm for cable ducts and flush mounted boxes





to DIN 49440-1, 2 p+E, 230 V. Other versions available on request.

PRODUCT INFORMATION

	Colour	Ampere	Voltage	with shutter	plug-in terminals	screw terminals
 <p>Panel mounted receptacle SCHUKO® for stationary use, with hinged lid, 3 plug-in terminals or 3 screw terminals as connecting terminals for 1.5 - 2.5 mm²</p> <p>IP54 Std. Pack: 100/20</p>	grey	16	230		11010	11030
	blue	16	230		11011	11031
	black	16	230		11012	11032
	red	16	230		11013	11033
	grey	16	230	•	11060	
	blue	16	230	•	11061	11081
 <p>Panel mounted receptacle SCHUKO® with front gasket for portable use, with front gasket, with hinged lid, 3 plug-in terminals or 3 screw terminals as connecting terminals for 1.5 - 2.5 mm²</p> <p>IP54 Std. Pack: 100</p>	grey	16	230		11310	11330
	blue	16	230		11311	11331
	black	16	230		11312	11332
	red	16	230		11313	11333
 <p>Panel mounted receptacle SCHUKO® without hinged lid, 3 plug-in terminals or 3 screw terminals as connecting terminals for 1.5 - 2.5 mm²</p> <p>IP20 Std. Pack: 100</p>	blue	16	230		11511	11531
	black	16	230		11512	11532
	blue	16	230	•	11561	11581



to DIN 49440-1, 2 p+E, 230 V, French/Belgian system (NF). Other versions available on request.

PRODUCT INFORMATION

	Colour	Ampere	Voltage	with shutter	plug-in terminals	screw terminals
 <p>Wall mounted receptacle SCHUKO® with hinged lid, 3 plug-in terminals as connecting terminals for 1.5 - 2.5 mm², cable entry M 20 x 1.5 at top and blind entry (for cut out) M 20 x 1.5 at bottom, can be arranged in a row using slot and slide IP44 Std. Pack: 10</p>	grey	16	230		10081	
	blue	16	230		10082	
	black	16	230		10083	
 <p>Wall mounted receptacle grounding-type French-belgian standard, with hinged lid, 3 plug-in terminals as connecting terminals for 1.5 - 2.5 mm², cable entry: M 20 x 1,5 at top with cable gland and M 20 x 1,5 blind (to be cut out) at the bottom, can be arranged in a row using slot and slide IP44 Std. Pack: 10</p>	blue	16	230	•	10092	
 <p>Panel mounted receptacle grounding-type French/Belgian system (NF), with hinged lid, 3 plug-in terminals or 3 screw terminals as connecting terminals for 1.5 - 2.5 mm² IP44 Std. Pack: 10</p>	grey	16	230		11110	
	blue	16	230		11111	11131
	grey	16	230	•	11160	11180
	blue	16	230	•	11161	11181
	black	16	230	•	11162	11182

to DIN 49440-1, 2 p+E, 230 V, French/Belgian system (NF), British standard. Other versions available on request.

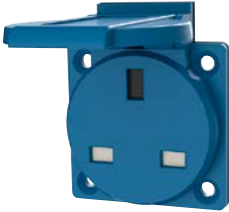
PRODUCT INFORMATION

	Colour	Ampere	Voltage	with shutter	plug-in terminals	screw terminals
 <p>Panel mounted receptacle grounding-type French/Belgian system (NF), without hinged lid, 3 plug-in terminals or 3 screw terminals as connecting terminals for 1.5 - 2.5 mm²</p> <p>IP20 Std. Pack: 100/20</p>	blue	16	230	•	11611	
	blue	16	230		11661	11681
 <p>Panel mounted receptacle grounding-type British standard, with hinged lid, 3 screw terminals</p> <p>IP44 Std. Pack: 20</p>	blue	13	230	•		10718
 <p>Panel mounted receptacle grounding-type British standard, with hinged lid, 3 screw terminals, with matching frame and seal</p> <p>IP44 Std. Pack: 20</p>	black	13	230	•		10713

NEMA 5-15, 2 p+E, 125 V. Other versions available on request.

PRODUCT INFORMATION

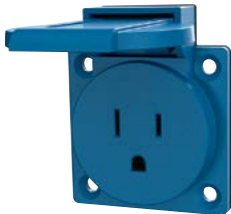
	Colour	Ampere	Voltage	with shutter	plug-in terminals	screw terminals
 <p>Panel mounted receptacle NEMA NEMA for the USA and Canada, with hinged lid, with 3 screw terminals</p> <p>IP44 Std. Pack: 20</p>	blue	15	125			10087

to DIN 49440-1, 2 p+E, 230 V. Other versions available on request.

PRODUCT INFORMATION

		Colour	Ampere	Voltage	Part no.
 <p>Plug SCHUKO® with combined PE-conductor acc. to German and French-Belgian standard, with grommet, for cables up to 3 x 2.5 mm² up to H07RN-F</p> <p>IP44 Std. Pack: 20</p>		grey	16	230	10749
		black	16	230	10754
		orange	16	230	10837
		blue	16	230	10838
		red	16	230	10839
		yellow	16	230	10840
		green	16	230	10841
 <p>Connector SCHUKO® with grommet and lid, for cables up to 3 x 2.5 mm² up to H07RN-F</p> <p>IP44 Std. Pack: 10</p>		grey	16	230	10751
		black	16	230	10755
		orange	16	230	10842
		blue	16	230	10843
		red	16	230	10844
		yellow	16	230	10845
		green	16	230	10846

to DIN 49442/43 and DIN VDE 0620. Other versions available on request.

PRODUCT INFORMATION

	Colour	Ampere	Voltage	with shutter	plug-in terminals	screw terminals
 <p>Wall mounted receptacle SCHUKO® with hinged bayonet lock lid</p> <p>IP68 Std. Pack: 10</p>	blue/grey	16	230			10863
 <p>Panel mounted receptacle SCHUKO® or NF with hinged bayonet lock lid, rectangular flange, four fixing holes</p> <p>IP68 Std. Pack: 10</p>	blue/grey	16	230		17002	17006
	blue/grey	16	230	•		17014
	NF					
	blue/grey	16	230	•	17060	17064

to DIN 49442/43 and DIN VDE 0620. Other versions available on request.

PRODUCT INFORMATION

	Colour	Ampere	Voltage	plug-in terminals	screw terminals
 <p>Plug SCHUKO® with combined PE-conductor acc. to German and French-Belgian standard, with bayonet ring, protective cap attached by a strap, for cables up to 3 x 2.5 mm², up to H07RN-F</p> <p>IP68 Std. Pack: 10</p>	blue/grey	16	230		10828
 <p>Connector SCHUKO® with bayonet lock lid attached by a strap, for cables up to 3 x 2.5 mm², up to H07RN-F</p> <p>IP68 Std. Pack: 10</p>	blue/grey	16	230		10833

7 pole For multifunctional applications.

These 7 pole plugs and sockets provide solutions where there are multifunctional requirements in industry, farming and commerce.

This number of poles provides solutions in the following fields:

- Star-delta start-up
- Closed loop control
- Open loop control
- Monitoring
- Detection and alarms
- Clearing alarms
- Electrical interlocking



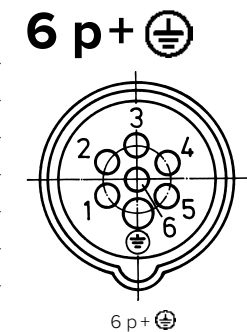

Position of ground contact tube with respect to polarisation keyway, designated by clockface position for 6 p + , 16 A and 32 A.

Frequency Hz	Rated operating voltage V	Position of ground contact
100 to 300	above 50	10
above 300 to 500	above 50	2
50	110	4
	230	9
	400	6
	500	7
50	220 to 240 downstream from isolating transformer	12





to IEC 60309-1, EN IEC 60309-1, DIN EN IEC 60309-1 (VDE 0623-1), DUO-Interlock to IEC 60309-4, EN IEC 60309-4, DIN EN IEC 60309-4 (VDE 0623-3).
 Colour: light grey and/or colour code. Highly resistant to chemicals. Other voltages and frequencies available on request.

PRODUCT INFORMATION

		A	P	230 V 50 a. 60 Hz	400 V 50 a. 60 Hz	500 V 50 a. 60 Hz
				7 p 9 h	7 p 6 h	7 p 7 h
 <p>Wall mounted receptacle with highly heat resistant contact carrier, nickel plated contacts, internal fixing, one cable entry at the top, two blind entries (can be cut out) at the bottom, enclosure base can be turned 180°</p> <p>IP44 Std. Pack: 10</p>	16	7	733	734	1035	
	32	7	735	736	1040	
 <p>Wall mounted receptacle highly resistant to chemicals, highly heat resistant contact carrier, nickel plated contacts, 2 external fixings, enclosure can be turned 180°</p> <p> IP67 Std. Pack: 10</p>	16	7	9530	9531	9532	
	32	7	9590	9591		
 <p>Wall mounted receptacle switched, mechanical DUO-interlock, highly heat resistant contact carrier, nickel plated contacts, 6 pole switch with 2 auxiliary contacts (1 NO and 1 NC), receptacles can be padlocked</p> <p>IP67 Std. Pack: 1</p>	with 6 pole switch:					
	16	7		7306		
	32	7		7307		
	with 3 pole switch:					
	16	7		5785		
	32	7		6106		



to IEC 60309-1, EN IEC 60309-1, DIN EN IEC 60309-1 (VDE 0623-1). Colour: light grey and/or colour code. Other voltages and frequencies available on request.

PRODUCT INFORMATION

		A	P	230 V 50 a. 60 Hz	400 V 50 a. 60 Hz	500 V 50 a. 60 Hz
				7 p 9 h	7 p 6 h	7 p 7 h
 <p>Panel mounted receptacle highly heat resistant contact carrier, nickel plated contacts, 20° inclination</p> <p>IP44 Std. Pack: 10</p>	16	7	737	738	1045	
	32	7		740	1050	
 <p>Panel mounted receptacle highly heat resistant contact carrier, nickel plated contacts, 20° inclination</p> <p>IP67 StdPack. Qty: 10</p>	16	7	2883	2459	2296	
	32	7	3775	2317	2212	
 <p>Plug AM-TOP highly heat resistant contact carrier, nickel plated contacts, single part body, cable gland and sealing, strain relief and protection against kinking</p> <p>IP44 Std. Pack: 10</p>	16	7	741	742	1055	
	32	7	743	744	1060	



to IEC 60309-1, EN IEC 60309-1, DIN EN IEC 60309-1 (VDE 0623-1). Colour: light grey and/or colour code. Other voltages and frequencies available on request.

PRODUCT INFORMATION



		A	P	230 V 50 a. 60 Hz	400 V 50 a. 60 Hz	500 V 50 a. 60 Hz
				7 p	7 p	7 p
				9 h	6 h	7 h
 <p>Plug AM-TOP highly heat resistant contact carrier, nickel plated contacts, single part body, cable gland and sealing, strain relief and protection against kinking</p> <p>IP67 Std. Pack: 10</p>	16	7	3776	3777	3913	
	32	7	2405	2324	2213	
 <p>Wall mounted inlet highly heat resistant contact carrier, nickel plated contacts, cable entry also possible on the back side</p> <p>IP44 Std. Pack: 10</p>	16	7		2166		
	32	7		2167		
 <p>Panel mounted inlet highly heat resistant contact carrier, nickel plated contacts</p> <p>IP44 Std. Pack: 10</p>	16	7	749	750	1075	
	32	7		752	1080	

to IEC 60309-1, EN IEC 60309-1, DIN EN IEC 60309-1 (VDE 0623-1). Colour: light grey and/or colour code. Other voltages and frequencies available on request.

PRODUCT INFORMATION

		A	P	230 V 50 a. 60 Hz	400 V 50 a. 60 Hz	500 V 50 a. 60 Hz
				7 p	7 p	7 p
				9 h	6 h	7 h
 <p>Panel mounted inlet highly heat resistant contact carrier, nickel plated contacts, with protective cap</p> <p>IP67 Std. Pack: 10</p>	16	7		3914		
	32	7		3915		
 <p>Connector AM-TOP highly heat resistant contact carrier, nickel plated contacts, single part body, cable gland and sealing, strain relief and protection against kinking</p> <p>IP44 Std. Pack: 10</p>	16	7	745	746	1065	
	32	7	747	748	1070	
 <p>Connector AM-TOP highly heat resistant contact carrier, nickel plated contacts, single part body, cable gland and sealing, strain relief and protection against kinking</p> <p>IP67 Std. Pack: 10</p>	16	7	3783	3916	3784	
	32	7		2255	2460	



to IEC 60309-2, EN IEC 60309-2, DIN EN IEC 60309-2 (VDE 0623-2), DUO-Interlock to IEC 60309-4, EN IEC 60309-4, DIN EN IEC 60309-4 (VDE 0623-3).
Colours: light grey and colour code.

		A	P	600 - 690 V 50 a, 60 Hz 5 p 5 h
 <p>Wall mounted receptacle screw terminals, internal fixing, enclosure base can be turned 180°</p> <p>IP44 Std. Pack: 10</p>		16	4	3790
		16	5	2766A
		32	4	2576A
		32	5	2767A
 <p>Wall mounted receptacle R screw terminals, pre-wired for installation, X-CONTACT, switched, mechanical DUO-interlock, highly heat resistant contact carrier, nickel plated contacts, 3 pole switch, sockets can be padlocked</p> <p>IP44 Std. Pack: 1</p>		16	4	5701405G
 <p>Wall mounted receptacle screw terminals, pre-wired for installation, X-CONTACT, switched, mechanical DUO-interlock, 3 pole switch, sockets can be padlocked</p> <p>IP44 Std. Pack: 1</p>		32	4	5603405G
		32	5	5603505G



to IEC 60309-2, EN IEC 60309-2, DIN EN IEC 60309-2 (VDE 0623-2), DUO-Interlock to IEC 60309-4, EN IEC 60309-4, DIN EN IEC 60309-4 (VDE 0623-3).
Colours: light grey and colour code.

		A	P	600 - 690 V
				50 a. 60 Hz 5 p 5 h
 <p>Wall mounted receptacle screw terminals, X-CONTACT, switched, mechanical DUO-interlock, highly heat resistant contact carrier, sockets can be padlocked</p> <p>IP44 Std. Pack: 3</p>	63	4	6580	
	63	5	6262A	
 <p>Wall mounted receptacle screw terminals, X-CONTACT, switched, mechanical DUO-interlock, highly heat resistant contact carrier</p> <p>IP67 Std. Pack: 1</p>	125	4	6015A	
	125	5	6077	



to IEC 60309-2, EN IEC 60309-2, DIN EN IEC 60309-2 (VDE 0623-2). Colours: light grey and colour code.

		A	P	600 - 690 V 50 a. 60 Hz 5 p 5 h
 <p>Panel mounted receptacle screw terminals, 20° inclination</p> <p>IP44 Std. Pack: 10</p>		16	4	3010
		16	5	2765A
		32	4	3011
		32	5	2764A
 <p>Panel mounted receptacle screw terminals, straight</p> <p>IP44 Std. Pack: 10</p>		16	4	3183
		16	5	3058
		32	4	3066
		32	5	3450
 <p>Panel mounted receptacle screw terminals, with pilot contact, X-CONTACT, highly heat resistant contact carrier, 20° inclination</p> <p>IP44 Std. Pack: 5</p>		63	5	2761P



to IEC 60309-2, EN IEC 60309-2, DIN EN IEC 60309-2 (VDE 0623-2). Colours: light grey and colour code.

		A	P	600 - 690 V 50 a, 60 Hz 5 p 5 h
 <p>Panel mounted receptacle screw terminals, with pilot contact, X-CONTACT, highly heat resistant contact carrier, straight</p> <p>IP44 Std. Pack: 5</p>	63	5	3115P	
 <p>Panel mounted receptacle screw terminals, with pilot contact, X-CONTACT, highly heat resistant contact carrier, 15° inclination</p> <p>IP67 Std. Pack: 5</p>	125	5	2546P	

to IEC 60309-2, EN IEC 60309-2, DIN EN IEC 60309-2 (VDE 0623-2). Colours: squirrel grey and colour code.

		A	P	600 - 690 V 50 a, 60 Hz 5 p 5 h
 <p>Plug PowerTOP Xtra R with ErgoCONTACT screw connection technology ErgoCONTACT, ergonomic enclosure design with nubbed grip areas, highly heat resistant contact carrier, nickel plated contacts, rubberised cable gland with sealing IP54 Std. Pack: 10</p>		16	4	13594
		16	5	13599
		32	4	13606
		32	5	13610
 <p>Plug PowerTOP Xtra R screw terminals, rubberised grip area, frame terminals, highly heat resistant contact carrier, nickel plated contacts, cable gland and sealing, strain relief and protection against kinking, enclosure with thread lock, two safety slides IP54 Std. Pack: 5</p>		63	4	13136
		63	5	13137
 <p>Plug PowerTOP Xtra R screw terminals, rubberised grip area, frame terminals, highly heat resistant contact carrier, nickel plated contacts, cable gland and sealing, strain relief and protection against kinking, enclosure with thread lock, two safety slides IP67 Std. Pack: 5</p>		63	4	13236
		63	5	13237
		125	4	13238
		125	5	13239



to IEC 60309-2, EN IEC 60309-2, DIN EN IEC 60309-2 (VDE 0623-2). Colours: squirrel grey and colour code.

		A	P	600 - 690 V 50 a. 60 Hz 5 p 5 h
 <p>Connector PowerTOP Xtra R with ErgoCONTACT screw connection technology ErgoCONTACT, X-CONTACT, ergonomic enclosure design with nubbed grip areas, highly heat resistant contact carrier, nickel plated contacts, rubberised cable gland with sealing IP54 Std. Pack: 10</p>		16	4	14594
		16	5	14599
		32	4	14606
		32	5	14610
 <p>Connector PowerTOP Xtra screw terminals, rubberised grip area, frame terminals, X-CONTACT, highly heat resistant contact carrier, cable gland and sealing, strain relief and protection against kinking, enclosure with thread lock IP54 Std. Pack: 5</p>		63	5	14137P
 <p>Connector PowerTOP Xtra screw terminals, rubberised grip area, frame terminals, X-CONTACT, highly heat resistant contact carrier, cable gland and sealing, strain relief and protection against kinking, enclosure with thread lock IP67 Std. Pack: 5</p>		63	5	14237P



Colours: light grey and colour code.

		A	P	50 - 500 V
				50 a, 60 Hz 5 p 1 h
 <p>Wall mounted receptacle screw terminals, internal fixing, enclosure base can be turned 180° (for 5-pole design)</p> <p>IP44 Std. Pack: 10</p>	16	3	2684	
	16	5	2675	
 <p>Wall mounted receptacle screw terminals, internal fixing, one cable entry at top and one blind entry (can be cut out) at the bottom, enclosure base can be turned 180°, receptacles are designed for adding an auxiliary contact switch</p> <p>IP44 Std. Pack: 10</p>	16	5	2840A	
	32	4	2983A	
	32	5	2676A	
 <p>Wall mounted receptacle screw terminals, X-CONTACT, internal fixing, enclosure base can be turned 180°</p> <p>IP44 Std. Pack: 5</p>	63	5	3719	



Colours: light grey and colour code.

		A	P	50 - 500 V
				50 a, 60 Hz 5 p 1 h
	<p>Wall mounted receptacle screw terminals, highly resistant to chemicals, two external fixing points, receptacles are designed for adding an auxiliary contact switch, enclosure base can be turned 180°</p> <p>IP67 Std. Pack: 5</p>	16	5	9343
	<p>Wall mounted receptacle screw terminals, X-CONTACT, internal fixing, highly heat resistant contact carrier, nickel plated contacts, enclosure base can be turned 180°</p> <p>IP67 Std. Pack: 5</p>	63	5	20151
	<p>Wall mounted receptacle screw terminals, X-CONTACT, internal fixing, highly heat resistant contact carrier, nickel plated contacts, enclosure base can be turned 180°</p> <p>IP67 Std. Pack: 1</p>	125	5	20152



Colours: light grey and colour code.

		A	P	50 - 500 V
				50 a, 60 Hz 5 p 1 h
 <p>Panel mounted receptacle screw terminals, straight</p> <p>IP44 Std. Pack: 10</p>	16	3	2973A	
	16	5	2917A	
	32	5	2997A	
 <p>Panel mounted receptacle screw terminals, straight</p> <p>IP67 Std. Pack: 10</p>	16	5	24563	
	32	5	246A	
 <p>Panel mounted receptacle screw terminals, 20° inclination</p> <p>IP67 Std. Pack: 10</p>	16	5	3650	



Colours: light grey and colour code.

		A	P	50 - 500 V
				50 a, 60 Hz 5 p 1 h
	Panel mounted receptacle screwless, with TwinCONTACT, suitable for through wiring, 20° inclination, receptacles optional fitted with auxiliary contact	32	5	1824
	IP67 Std. Pack: 10			
	Panel mounted receptacle screw terminals, X-CONTACT, straight	63	5	2873A
	IP67 Std. Pack: 5	125	5	1406
	Panel mounted receptacle screw terminals, X-CONTACT, 20° inclination, highly heat resistant contact carrier, nickel plated contacts	63	5	3233AA
	IP67 Std. Pack: 5			



Colours: light grey and colour code.

		A	P	50 - 500 V
 <p>Panel mounted receptacle screw terminals, X-CONTACT, 15° inclination</p> <p>IP67 Std. Pack: 5</p>				50 a, 60 Hz 5 p 1 h
		125	5	3713AA
 <p>Panel mounted inlet screw terminals, nickel plated contacts, a retaining nose to hold the hinged lid of the connector must be provided by the customer in order to ensure satisfactory locking</p> <p>IP67 Std. Pack: 10</p>		16	3	710
		16	5	811
		32	5	842
 <p>Panel mounted inlet screw terminals, highly heat resistant contact carrier, nickel plated contacts, a retaining nose to hold the hinged lid of the connector must be provided by the customer in order to ensure satisfactory locking</p> <p>IP67 Std. Pack: 5</p>		63	5	3606



Colours: light grey and colour code.

		A	P	50 - 500 V
				50 a, 60 Hz 5 p 1 h
	Panel mounted inlet screw terminals, highly heat resistant contact carrier, nickel plated contacts	125	5	1940
	IP67 Std. Pack: 5			
	Wall mounted inlet screw terminals	16	3	3230
		16	5	301
		32	5	311
	Wall mounted inlet screw terminals, internal fixing, with protective cover	16	5	8109251
		32	5	8109264
	IP67 Std. Pack: 2			

Colours: light grey / squirrel grey and colour code.

		A	P	50 - 500 V
				50 a, 60 Hz 5 p 1 h
 <p>Wall mounted inlet screw terminals, internal fixing, with protective cover</p> <p>IP67 Std. Pack: 1</p>	63	5	8617060	
	125	5	8617073	
 <p>Plug PowerTOP Xtra R with ErgoCONTACT screw connection technology ErgoCONTACT, highly heat resistant contact carrier, nickel plated contacts, ergonomic enclosure design with nubbed grip areas, rubberised cable gland with sealing IP54 Std. Pack: 10</p>	16	3	13588*	
	16	4	13592*	
	16	5	13597	
	32	4	13605*	
	32	5	13609	
* Available from 01.06.2024				
 <p>NEW Plug PowerTOP Xtra R with ErgoCONTACT screw connection technology ErgoCONTACT, ergonomic enclosure design with nubbed grip areas, highly heat resistant contact carrier, nickel plated contacts, rubberised bayonet ring, sealed against dust, temporary submersion and high-pressure cleaning IP67 / IP69 - Std. Pack: 10</p>	16	3	13665*	
	16	4	13669**	
	16	5	13674*	
	32	4	13678**	
	32	5	13682*	
		* Available from 01.08.2024		** Available from 01.11.2024

Colours: squirrel grey and colour code.

		A	P	50 - 500 V
				50 a, 60 Hz 5 p 1 h
	Plug PowerTOP Xtra R screw terminals, rubberised grip area, frame terminals, highly heat resistant contact carrier, nickel plated contacts, cable gland and sealing, strain relief and protection against kinking, enclosure with thread lock IP67 Std. Pack: 5	63	5	13248
		125	5	13259
	Connector PowerTOP Xtra R with ErgoCONTACT screw connection technology ErgoCONTACT, X-CONTACT, highly heat resistant contact carrier, nickel plated contacts, ergonomic enclosure design with nubbed grip areas, rubberised cable gland with sealing IP54 Std. Pack: 10	16	3	14588*
		16	4	14592*
		16	5	14597
		32	4	14605*
		32	5	14609
				* Available from 01.06.2024
	NEW Connector PowerTOP Xtra R with ErgoCONTACT screw connection technology ErgoCONTACT, X-CONTACT, ergonomic enclosure design with nubbed grip areas, highly heat resistant contact carrier, nickel plated contacts, rubberised bayonet ring, sealed against dust, temporary submersion and high-pressure cleaning IP67 / IP69 - Std. Pack: 10	16	3	14665*
		16	4	14669**
		16	5	14674*
		32	4	14678**
		32	5	14682*
				* Available from 01.08.2024 ** Available from 01.11.2024

Colours: squirrel grey and colour code.

		A	P	50 - 500 V
				50 a, 60 Hz 5 p 1 h
 <p>Connector PowerTOP Xtra rubberised grip area, X-CONTACT, highly heat resistant contact carrier, frame terminals, cable gland and sealing, strain relief and protection against kinking, enclosure with thread lock</p> <p>IP67 Std. Pack: 5</p>	63	5	14248	
	125	5	14259	

Low voltages

When portable electric appliances are used in environments where conductive materials are present and where movement is restricted, they must be operated at low voltage or they must be electrically isolated, e.g. in or on boilers, containers, pipework systems, steel scaffolding or similar installations. The same applies to rooms containing exposed conductive materials. Portable lamps must be operated at low voltage.

Stationary appliances may be operated at a safe low voltage or they may be electrically isolated, e.g. lamps installed temporarily for maintenance purposes, cleaning or other types of work, which are connected to the power supply by means of movable cables. Only use tools of protection type II or III. Also, lamps for barrels and movable lamps for ovens must be operated at low voltage.

Furthermore, low voltage 25 V AC should be used for all mobile appliances without insulation which are used on animals, e.g. shears, milking machines, etc.

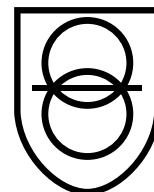

Requirements on plugs and sockets for low voltages.

Plugs and sockets must be different from those used at other voltages and must not be provided with an earth contact (DIN VDE 0100-410 (VDE 0100-410):2018).





to IEC 60309-2, EN IEC 60309-2, DIN EN IEC 60309-2 (VDE 0623-2). Other voltages and frequencies available on request.

PRODUCT INFORMATION

		A	P	20 - 25 V 50 a. 60 Hz	40 - 50 V 50 a. 60 Hz	20 - 25 V 40 - 50 V 100 - 200 Hz	20 - 25 V 40 - 50 V = = =
 <p>Wall mounted receptacle external fixing, one cable entry at top and one blind cable entry (can be cut out) at the rear side</p> <p>IP44 Std. Pack: 10</p>	16	2	1825	1831	4 h	1829	
	16	3	1832	1837	1835		
	32	2	1838	1844		1842	
	32	3	1845	1850	1848		
 <p>Wall mounted receptacle internal fixing, one cable entry at top and two blind entries (can be cut out) at bottom, lower part of enclosure base can be turned 180°</p> <p>IP44 Std. Pack: 10</p>	16	2	577	578		583	
	16	3	584	585			
	32	2		591		596	
	32	3	597	598	599		
 <p>Panel mounted receptacle straight</p> <p>IP44 Std. Pack: 10</p>	16	2	603	604		609	
	16	3	610	611	612		
	32	2	616	617		622	
	32	3	623	624	625		



to IEC 60309-2, EN IEC 60309-2, DIN EN IEC 60309-2 (VDE 0623-2). Other voltages and frequencies available on request.

PRODUCT INFORMATION



		A	P	20 - 25 V 50 a. 60 Hz	40 - 50 V 50 a. 60 Hz	20 - 25 V 40 - 50 V 100 - 200 Hz	20 - 25 V 40 - 50 V = = =
 <p>Panel mounted receptacle straight</p> <p>IP44 Std. Pack: 10</p>		16	2	1602	1603		2617A
		16	3	1657	1661		
		32	2	1693			2488A
		32	3		1595	1579	
 <p>Panel mounted receptacle 20° inclination</p> <p>IP44 Std. Pack: 10</p>		16	2	1270	2855		2841
		16	3	2845	1272		
		32	2	1271	2864		2869
		32	3	2870	1273	2852	
 <p>Panel mounted receptacle 20° inclination</p> <p>IP44 Std. Pack: 10</p>		32	3			2837	

to IEC 60309-2, EN IEC 60309-2, DIN EN IEC 60309-2 (VDE 0623-2). Other voltages and frequencies available on request.



PRODUCT INFORMATION

		A	P	20 - 25 V 50 a. 60 Hz	40 - 50 V 50 a. 60 Hz	20 - 25 V 40 - 50 V 100 - 200 Hz	20 - 25 V 40 - 50 V = = =
 <p>Plug with cable gland</p> <p>IP44 Std. Pack: 10</p>		16	2	655A	656A	4 h	661A
		16	3	662A	663A	664A	
		32	2	668A	669A		674A
		32	3	675A	676A	677A	
 <p>Wall mounted inlet external fixing, one cable entry at top and one blind cable entry (can be cut out) at the back side</p> <p>IP44 Std. Pack: 10</p>		16	2	1955	1961		1959
		16	3	1962	1967		
		32	2	1968			1972
		32	3	1975	1980	1978	
 <p>Connector with cable gland</p> <p>IP44 Std. Pack: 10</p>		16	2	707A	708A		713A
		16	3	714A	715A	716A	
		32	2	720A	721A		
		32	3		728A	729A	



Colour: light grey and colour code. Other versions available on request.

		A	P	Isolation transformer
				5 p 12 h
 <p>Wall mounted receptacle screw terminals, internal fixing, in 4 pole version enclosure base can be turned 180°</p> <p>IP44 Std. Pack: 10</p>	16	3	767	
	16	4	768	
 <p>Wall mounted receptacle screw terminals, internal fixing, enclosure base can be turned 180°</p> <p>IP44 Std. Pack: 10</p>	32	4	3147	
 <p>Wall mounted receptacle screw terminals, highly resistant to chemicals, with 2 external fixing points, receptacles are designed for adding an auxiliary contact switch, enclosure can be turned 180°</p> <p>IP67 Std. Pack: 10</p>	16	3	9304	
	16	4	9327	



Colour: light grey and colour code. Other versions available on request.

		A	P	Isolation transformer
 <p>Panel mounted receptacle screw terminals, 20° inclination</p> <p>IP44 Std. Pack: 10</p>	16	3	5 p 12 h 3217	
	16	4	3218	
 <p>Panel mounted receptacle screw terminals, straight</p> <p>IP44 Std. Pack: 10</p>	16	3	3221	
 <p>Panel mounted receptacle screw terminals, straight</p> <p>IP44 Std. Pack: 10</p>	16	3	3053	
	16	4	3052	

Colour: light grey or squirrel grey and colour code. Other versions available on request.

		A	P	Isolation transformer
				5 p 12 h
 <p>Panel mounted receptacle screw terminals, straight</p> <p>IP67 Std. Pack: 10</p>	16	3	806A	
	32	3	808A	
 <p>Plug PowerTOP Xtra R with ErgoCONTACT screw connection technology ErgoCONTACT, ergonomic enclosure design with nubbed grip areas, highly heat resistant contact carrier, nickel plated contacts, rubberised cable gland with sealing IP54 Std. Pack: 10</p>	16	3	13591*	
	16	4	13596*	
	16	5	13601	
	32	3	13604*	
	32	4	13608*	
	32	5	13613	
	* Available from 01.06.2024			
 <p>NEW Plug PowerTOP Xtra R with ErgoCONTACT screw connection technology ErgoCONTACT, ergonomic enclosure design with nubbed grip areas, highly heat resistant contact carrier, nickel plated contacts, rubberised bayonet ring, sealed against dust, temporary submersion and high-pressure cleaning IP67 / IP69 - Std. Pack: 10</p>	16	3	13668*	
	16	4	13673**	
	32	3	13677**	
	32	4	13681*	
	* Available from 01.08.2024		** Available from 01.11.2024	

Colour: squirrel grey and colour code. Other versions available on request.

		A	P	Isolation transformer
				5 p 12 h
 <p>Connector PowerTOP Xtra R with ErgoCONTACT screw connection technology ErgoCONTACT, X-CONTACT, ergonomic enclosure design with nubbed grip areas, highly heat resistant contact carrier, nickel plated contacts, rubberised cable gland with sealing IP54 Std. Pack: 10</p>	16	3	14591*	
	16	4	14596*	
	16	5	14601	
	32	3	14604*	
	32	4	14608*	
				* Available from 01.06.2024
 <p>NEW Connector PowerTOP Xtra R with ErgoCONTACT screw connection technology ErgoCONTACT, X-CONTACT, ergonomic enclosure design with nubbed grip areas, highly heat resistant contact carrier, nickel plated contacts, rubberised bayonet ring, sealed against dust, temporary submersion and high-pressure cleaning IP67 / IP69 - Std. Pack: 10</p>	16	3	14668*	
	16	4	14673**	
	32	3	14677**	
	32	4	14681**	
			* Available from 01.08.2024	** Available from 01.11.2024

160 A - 600 A

Heavy duty versions for industry.



The heavy-duty series plugs and sockets extend the currently standardized plugs and sockets according to EN 60309-2 by rated currents from 160 A to 600 A as well as rated voltages of up to 1000 V. They are built in accordance with the following standards: IEC / EN IEC 60309-1.

Finger-safe thanks to contact covers.

The contact jacks on the receptacles and connectors are equipped with contact covers, which reliably prevent coming into contact with live contact jacks. Finger-safe as defined by IEC / EN IEC 60309-1.

160 A - 600 A

Heavy duty versions for industry.

Mechanical lock.

For non-stationary electrical consumers with a rated current > 125 A, the heavy-duty series with 160 A, 200 A, 250 A, 400 A and 600 A is included as part of the range. This series is suitable for rated voltages from 230 V to 1000 V.

A seawater resistant version is also available for all devices.

The heavy-duty series is designated for use in extremely harsh conditions. For example:

- at construction sites
- on drilling rigs and conveyor systems
- for tunnel construction
- in quarry pits
- in gravel quarries
- in opencast mining
- for crane installations at ports and container ports
- at airports
- as a flexible power supply at major events
- to supply market places
- also available in seawater resistant version



160 A - 600 A

Heavy duty versions for industry.

Surface protection for contacts.

Surface protection against aggressive atmospheres and harsh ambient conditions. Contacts up to 200 A are nickel-plated as standard. Starting with 250 A, the contacts are silver-plated. In order to reduce downtimes, 250 A devices or higher are designed for quick replacement of worn parts. Without opening the device or removing the cable, the contact pins and jacks can be replaced by unscrewing the front section from the terminal.



Search

Outer strain relief for simple cable insertion.

Plugs, connectors, inlets and wall mounted receptacles are supplied with trumpet-shaped cable glands suitable for cable diameters from 34 to 66 mm (160 A to 400 A), or 55 to 85 mm (600 A). The outer strain relief facilitates cable insertion and ensures that the cable remains securely seated in the wiring device.

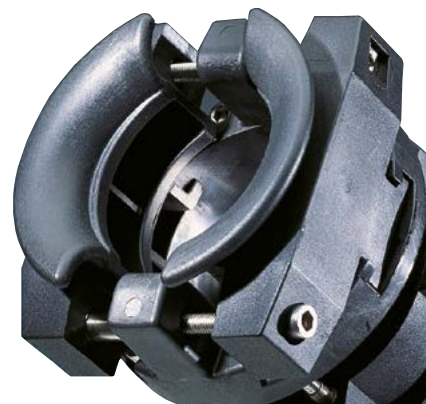

You can find more information on our website

Pilot contact.



All plugs and sockets come equipped with two pilot contacts as standard. The contacts are lagging when making contact and leading while breaking contact. If necessary, plugs and sockets can be interlocked electrically.



Index



Built in accordance with IEC 60309-1, EN IEC 60309-1, DIN EN IEC 60309-1 (VDE 0623-1). Enclosure made of aluminum and/or plastic or sheet steel. Voltages and frequencies that are not listed, larger cable inlets, enclosures made of plastic or stainless steel available on request. A seawater resistant version is also available for all devices.

PRODUCT INFORMATION

		A	P	400 V 50 a. 60 Hz 4 p 5 p 6 h 6 h	500 V 50 a. 60 Hz 4 p 5 p 7 h 7 h
 <p>Wall mounted receptacle plastic enclosure, aluminium front part, screw terminals, external fixing, cable entry at top, with cable gland</p> <p>IP67 Std. Pack: 1</p>	160	4	75080	75081	
	160	5	75310		
 <p>Wall mounted receptacle plastic enclosure, aluminium front part, screw terminals, external fixing, cable entry at top, with cable gland</p> <p>IP67 Std. Pack: 1</p>	200	4	75221	75222	
	200	5	75226		
	250	4	75327	75328	
	250	5	75329		
 <p>Wall mounted receptacle aluminum enclosure, screw terminals, external fixing, cable entry at top, with cable gland</p> <p>IP67 Std. Pack: 1</p>	250	4	75021	75022	
	250	5	75111		
	400	4	75026		
	400	5	75116		



Built in accordance with IEC 60309-1, EN IEC 60309-1, DIN EN IEC 60309-1 (VDE 0623-1). Enclosure made of aluminum and/or plastic or sheet steel. Voltages and frequencies that are not listed, larger cable inlets, enclosures made of plastic or stainless steel available on request. A seawater resistant version is also available for all devices.

PRODUCT INFORMATION

	A	P	400 V 50 a. 60 Hz 4 p 5 p 6 h 6 h	500 V 50 a. 60 Hz 4 p 5 p 7 h 7 h
 <p>Wall mounted receptacle aluminum enclosure, screw terminals, external fixing, cable entry at top, with cable gland</p> <p>IP67 Std. Pack: 1</p>	600	4	75339	
	600	5	75142	
 <p>Wall mounted receptacle DUO screw terminals, switched, mechanical interlock, cable entry bushing for cables of 20 mm up to 70 mm at top and blind flange at bottom, enclosure made of sheet steel, painted in RAL 1021</p> <p>IP55 Std. Pack: 1</p>	160	4	75143	
	160	5	75144	
 <p>Wall mounted receptacle DUO screw terminals, switched, mechanical interlock, cable entry bushing for cables of 20 mm up to 70 mm at top and blind flange at bottom, enclosure made of sheet steel, painted in RAL 1021</p> <p>IP55 Std. Pack: 1</p>	200	4	75231	
	200	5	75236	



Built in accordance with IEC 60309-1, EN IEC 60309-1, DIN EN IEC 60309-1 (VDE 0623-1). Enclosure made of aluminum and/or plastic or sheet steel. Voltages and frequencies that are not listed, larger cable inlets, enclosures made of plastic or stainless steel available on request. A seawater resistant version is also available for all devices.

PRODUCT INFORMATION

		A	P	400 V 50 a. 60 Hz 4 p 5 p 6 h 6 h	500 V 50 a. 60 Hz 4 p 5 p 7 h 7 h
	Wall mounted receptacle DUO screw terminals, switched, mechanical interlock, cable entry bushing for cables of 20 mm up to 70 mm at top and blind flange at bottom, enclosure made of sheet steel, painted in RAL 1021 IP67 Std. Pack: 1	250	4	75145	
		250	5	75146	
	Wall mounted receptacle DUO screw terminals, switched, mechanical interlock, cable entry bushing for cables of 20 mm up to 70 mm at top and blind flange at bottom, enclosure made of sheet steel, painted in RAL 1021 IP55 Std. Pack: 1	250	4	75031	
		250	5	75121	
		400	4	75036	
		400	5	75126	
	Wall mounted receptacle DUO screw terminals, switched, mechanical interlock, cable entry bushing for cables of 20 mm up to 70 mm at top and blind flange at bottom, enclosure made of sheet steel, painted in RAL 1021 IP55 Std. Pack: 1	600	4	75147	
		600	5	75148	



Built in accordance with IEC 60309-1, EN IEC 60309-1, DIN EN IEC 60309-1 (VDE 0623-1). Enclosure made of aluminum and/or plastic or sheet steel. Voltages and frequencies that are not listed, larger cable inlets, enclosures made of plastic or stainless steel available on request. A seawater resistant version is also available for all devices.

PRODUCT INFORMATION

		A	P	400 V 50 a. 60 Hz 4 p 5 p 6 h 6 h	500 V 50 a. 60 Hz 4 p 5 p 7 h 7 h
 <p>Wall mounted receptacle electrical interlock screw terminals, electrical interlock with contactor, cable entry bushing for cables of 20 mm up to 70 mm at top and blind flange at bottom, enclosure made of sheet steel, painted in RAL 1021</p> <p>IP55 Std. Pack: 1</p>	200	5	75276		
 <p>Wall mounted receptacle electrical interlock screw terminals, electrical interlock with contactor, cable entry bushing for cables of 20 mm up to 70 mm at top and blind flange at bottom, enclosure made of sheet steel, painted in RAL 1021</p> <p>IP55 Std. Pack: 1</p>	250	5	75441		
	400	5	75448		



Built in accordance with IEC 60309-1, EN IEC 60309-1, DIN EN IEC 60309-1 (VDE 0623-1). Enclosure made of aluminum and/or plastic or sheet steel. Voltages and frequencies that are not listed, larger cable inlets, enclosures made of plastic or stainless steel available on request. A seawater resistant version is also available for all devices.

PRODUCT INFORMATION

		A	P	400 V 50 a. 60 Hz 4 p 5 p 6 h 6 h	500 V 50 a. 60 Hz 4 p 5 p 7 h 7 h
 <p>Panel mounted receptacle aluminum enclosure, screw terminals</p> <p>IP67 Std. Pack: 1</p>	160	4	75067	75069	
	160	5	75070		
 <p>Panel mounted receptacle aluminum enclosure, screw terminals</p> <p>IP67 Std. Pack: 1</p>	200	4	75241	75242	
	200	5	75246		
	250	4	75320	75322	
	250	5	75323		
 <p>Panel mounted receptacle aluminum enclosure, screw terminals</p> <p>IP67 Std. Pack: 1</p>	250	4	75041	75042	
	250	5	75131		
	400	4	75046		
	400	5	75136		



Built in accordance with IEC 60309-1, EN IEC 60309-1, DIN EN IEC 60309-1 (VDE 0623-1). Enclosure made of aluminum and/or plastic or sheet steel. Voltages and frequencies that are not listed, larger cable inlets, enclosures made of plastic or stainless steel available on request. A seawater resistant version is also available for all devices.

PRODUCT INFORMATION

		A	P	400 V 50 a. 60 Hz 4 p 5 p 6 h 6 h	500 V 50 a. 60 Hz 4 p 5 p 7 h 7 h
 <p>Panel mounted receptacle aluminum enclosure, screw terminals</p> <p>IP67 Std. Pack: 1</p>	600	4	75335		
	600	5	75337		
 <p>Panel mounted receptacle aluminum enclosure, screw terminals, 15° inclination</p> <p>IP67 Std. Pack: 1</p>	200	4	75053		
	200	5	75058		
 <p>Panel mounted receptacle screw terminals, 15° inclination</p> <p>IP67 Std. Pack: 1</p>	250	4	75063		
	250	5	75068		
	400	4	75073	75074	
	400	5	75078		



Built in accordance with IEC 60309-1, EN IEC 60309-1, DIN EN IEC 60309-1 (VDE 0623-1). Enclosure made of aluminum and/or plastic or sheet steel. Voltages and frequencies that are not listed, larger cable inlets, enclosures made of plastic or stainless steel available on request. A seawater resistant version is also available for all devices.

PRODUCT INFORMATION

		A	P	400 V 50 a. 60 Hz 4 p 5 p 6 h 6 h	500 V 50 a. 60 Hz 4 p 5 p 7 h 7 h
 <p>Plug plastic enclosure, aluminium front part, screw terminals, with cable gland</p> <p>IP67 Std. Pack: 1</p>	160	4	75055	75056	
	160	5	75057		
 <p>Plug plastic enclosure, aluminium front part, screw terminals, with cable gland</p> <p>IP67 Std. Pack: 1</p>	200	4	75201	75202	
	200	5	75206		
	250	4	75312	75313	
	250	5	75075		
 <p>Plug aluminum enclosure, screw terminals, with cable gland</p> <p>IP67 Std. Pack: 1</p>	250	4	75001	75002	
	250	5	75091		
	400	4	75006	75007	
	400	5	75096		

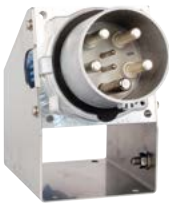

Built in accordance with IEC 60309-1, EN IEC 60309-1, DIN EN IEC 60309-1 (VDE 0623-1). Enclosure made of aluminum and/or plastic or sheet steel. Voltages and frequencies that are not listed, larger cable inlets, enclosures made of plastic or stainless steel available on request. A seawater resistant version is also available for all devices.

PRODUCT INFORMATION

		A	P	400 V 50 a. 60 Hz 4 p 5 p 6 h 6 h	500 V 50 a. 60 Hz 4 p 5 p 7 h 7 h
 <p>Plug aluminum enclosure, screw terminals, with cable gland</p> <p>IP67 Std. Pack: 1</p>		600	4	75330	
		600	5	75332	
 <p>Wall mounted inlet aluminum enclosure, screw terminals</p> <p>IP67 Std. Pack: 1</p>		160	5	75077	
 <p>Wall mounted inlet aluminum enclosure, screw terminals</p> <p>IP67 Std. Pack: 1</p>		200	5	75256	
		250	5	75325	



Built in accordance with IEC 60309-1, EN IEC 60309-1, DIN EN IEC 60309-1 (VDE 0623-1). Enclosure made of aluminum and/or plastic or sheet steel. Voltages and frequencies that are not listed, larger cable inlets, enclosures made of plastic or stainless steel available on request. A seawater resistant version is also available for all devices.

PRODUCT INFORMATION

		A	P	400 V 50 a. 60 Hz 4 p 5 p 6 h 6 h	500 V 50 a. 60 Hz 4 p 5 p 7 h 7 h
 <p>Wall mounted inlet aluminum enclosure, screw terminals</p> <p>IP67 Std. Pack: 1</p>		250	5	75173	
		400	4	75389	
		400	5	75398	
 <p>Wall mounted inlet aluminum enclosure, screw terminals</p> <p>IP67 Std. Pack: 1</p>		600	4	75338	
 <p>Panel mounted inlet aluminum enclosure, screw terminals</p> <p>IP67 Std. Pack: 1</p>		160	5	75066	



Built in accordance with IEC 60309-1, EN IEC 60309-1, DIN EN IEC 60309-1 (VDE 0623-1). Enclosure made of aluminum and/or plastic or sheet steel. Voltages and frequencies that are not listed, larger cable inlets, enclosures made of plastic or stainless steel available on request. A seawater resistant version is also available for all devices.

PRODUCT INFORMATION

		A	P	400 V 50 a. 60 Hz 4 p 5 p 6 h 6 h	500 V 50 a. 60 Hz 4 p 5 p 7 h 7 h
 <p>Panel mounted inlet aluminum enclosure, screw terminals</p> <p>IP67 Std. Pack: 1</p>	200	4	75261		
	200	5	75266		
 <p>Panel mounted inlet aluminum enclosure, screw terminals</p> <p>IP67 Std. Pack: 1</p>	250	4	75284		
	250	5	75287		
	400	4	75291		
 <p>Panel mounted inlet, angled screw terminals, 15° inclination</p> <p>IP67 Std. Pack: 1</p>	200	5	75316		



Built in accordance with IEC 60309-1, EN IEC 60309-1, DIN EN IEC 60309-1 (VDE 0623-1). Enclosure made of aluminum and/or plastic or sheet steel. Voltages and frequencies that are not listed, larger cable inlets, enclosures made of plastic or stainless steel available on request. A seawater resistant version is also available for all devices.

PRODUCT INFORMATION

		A	P	400 V 50 a. 60 Hz 4 p 5 p 6 h 6 h	500 V 50 a. 60 Hz 4 p 5 p 7 h 7 h
 <p>Panel mounted inlet, angled aluminum enclosure, screw terminals, 15° inclination</p> <p>IP67 Std. Pack: 1</p>	250	5	75324		
 <p>Panel mounted inlet, angled aluminum enclosure, screw terminals, 15° inclination</p> <p>IP67 Std. Pack: 1</p>	250	4	75321		
	250	5	75326		
	400	4	75331		
	400	5	75336		
 <p>Connector plastic enclosure, aluminium front part, screw terminals, with cable gland</p> <p>IP67 Std. Pack: 1</p>	160	4	75059	75060	
	160	5	75065		

Built in accordance with IEC 60309-1, EN IEC 60309-1, DIN EN IEC 60309-1 (VDE 0623-1). Enclosure made of aluminum and/or plastic or sheet steel. Voltages and frequencies that are not listed, larger cable inlets, enclosures made of plastic or stainless steel available on request. A seawater resistant version is also available for all devices.

PRODUCT INFORMATION

		A	P	400 V 50 a. 60 Hz 4 p 5 p 6 h 6 h	500 V 50 a. 60 Hz 4 p 5 p 7 h 7 h
 <p>Connector plastic enclosure, aluminium front part, screw terminals, with cable gland</p> <p>IP67 Std. Pack: 1</p>		200	4	75211	75212
		200	5	75216	
		250	4	75317	
		250	5	75076	
 <p>Connector aluminum enclosure, screw terminals, with cable gland</p> <p>IP67 Std. Pack: 1</p>		250	4	75011	75012
		250	5	75101	
		400	4	75016	75017
		400	5	75106	
 <p>Connector aluminum enclosure, screw terminals, with cable gland</p> <p>IP67 Std. Pack: 1</p>		600	4	75333	
		600	5	75334	

Cepex data port sockets



- 1** The bottom part of the enclosure can be turned by 180 degrees, which allows cable insertion from above or below without additional work.
- 2** Protection type IP44 with closed cover or with plug inserted.
- 3** Suitable for double RJ45 ports, Cat. 3 to Cat. 7 and manufacturer-independent RJ45 Keystones. Openings according to IEC 60603-7.
- 4** Lockable even with connected cables. The safety lock prevents unauthorized access.
- 5** Visible labeling field.



Simple:

All types are equipped with a membrane gland fitting M 25 for two cables 3-9 mm. Simply push in the cable – done!

Extra:

A metric cable gland M 25 / 2 x 8 is optionally available.





ENERGY AND DATA

Protection type IP44.

The right choice for control stations, storage areas, laboratories, airports, production lines, etc. Cepex data port sockets are operated with standard patch cables and can be combined with Cepex receptacles CEE and/or SCHUKO®. For wall-/panel mounting or installation in cable ducts.

PRODUCT INFORMATION

	<p>Title</p> <p>Compact network distributor</p>	<p>Fitted with</p> <p>1 Cepex data port socket with 2 RJ45 connection modules, type E-DAT module, port, Cat.6, brand: METZ Connect</p> <p>2 SCHUKO® 16 A, 230 V</p>	<p>Cable entry</p> <p>2 x M 25 at the top (closed), 1 x M 25 at the bottom (with cable gland) 1 x M 25 2 x 8 at the bottom (with cable gland seal insert for 3 individual cables up to 5-7 mm Ø)</p>	<p>Connection</p> <p>with terminal for 1 cable up to 3 x 4 mm²</p>	<p>Enclosure size</p> <p>118 x 170 mm (H x W)</p>	<p>Part no.</p> <p>25705</p>
	<p>Title</p> <p>Compact network distributor</p>	<p>Fitted with</p> <p>1 Cepex data port socket module, port, Cat.6, brand: METZ Connect</p> <p>4 SCHUKO® 16 A, 230 V</p>	<p>Cable entry</p> <p>2 x M 25 at the top (closed) 1 x M 25 at the bottom (with cable gland) 1 x M 25 3 x 5-7 at the bottom (with cable gland) (seal insert for 2 individual cables up to 8 mm Ø)</p>	<p>Connection</p> <p>with terminal for 1 cable up to 5 x 4 mm²</p>	<p>Enclosure size</p> <p>260 x 160 mm (H x W)</p>	<p>Part no.</p> <p>25748</p>

ENERGY AND DATA

Protection type IP44.

The right choice for control stations, storage areas, laboratories, airports, production lines, etc. Cepex data port sockets are operated with standard patch cables and can be combined with Cepex receptacles CEE and/or SCHUKO®. For wall-/panel mounting or installation in cable ducts.



PRODUCT INFORMATION

	Title	Fitted with	Cable entry	Also available with	Enclosure size	Part no.
	Network enclosure AMAXX	2 Cepex data port sockets identical lock, prepared for 4 RJ45 connection module couplings, type E-DAT module, port, cat.6, brand: METZ Connect (part no. 41455) or OpDAT module LC or ST (brand METZ Connect - not delivery contains)	2 x M 25 at the top (closed), 2 x M 25 at the bottom (closed) and 2 x M 20 top and bottom (closed)	1 Cepex enclosure (part no.: 25104, 25104GE)	130 x 225 mm (H x W)	25102 grey

ENERGY AND DATA

Colours: light grey (RAL 7035), pure white (RAL 9010), grey (RAL 9006), deep black (RAL 9005).



PRODUCT INFORMATION

	Brand	Type	Data module	Part no.
 <p>Cepex enclosure, light grey as wall mounted receptacle, for installation of RJ45 data port sockets, with safety lock, 2 keys, identical lock: Part no. + Index "G"</p> <p>IP44 Std. Pack: 5</p>	CommScope	Twist	—	4350 ¹⁾
	CommScope	Jack	2 x 41457	4360
	CommScope	CO Plus	—	4370 *
	METZ Connect	E-DAT module	2 x 41455	4340 ³⁾
	Rutenbeck	iso-8/8 Up0S	1 x 41492	4320
	TKM	KDMF	1 x 41452	4300 ¹⁾
	Reichle & De-Massari	Module Real 10	2 x 25056	4375 ²⁾
 <p>Cepex enclosure, light grey as panel mounted receptacle, for installation of RJ45 data port sockets, 2 keys, identical lock: Part no. + Index "G"</p> <p>IP44 Std. Pack: 5</p>	CommScope	Jack	2 x 41457	4362
	METZ Connect	E-DAT module	2 x 41455	4342 ³⁾
	Rutenbeck	iso-8/8 Up0S	1 x 41492	4322
	Reichle & De-Massari	Module Real 10	2 x 25056	4377 ²⁾
 <p>Cepex enclosure, pure white as panel mounted receptacle, for installation of RJ45 data port sockets, 2 keys, identical lock: Part no. + Index "G"</p> <p>IP44 Std. Pack: 5</p>	CommScope	Jack	2 x 41457	4364
	METZ Connect	E-DAT module	2 x 41455	4344 ³⁾
	Rutenbeck	iso-8/8 Up0S	1 x 41492	4324
	TKM	KDMF	1 x 41452	4304 ¹⁾

ENERGY AND DATA

Colours: light grey (RAL 7035), pure white (RAL 9010), grey (RAL 9006), deep black (RAL 9005).

PRODUCT INFORMATION

	Brand	Type	Data module	Part no.
 <p>Cepex enclosure, grey as panel mounted receptacle, for installation of RJ45 data port sockets, 2 keys, identical lock: Part no. + Index "G"</p> <p>IP44 Std. Pack: 5</p>	Rutenbeck	iso-8/8 Up0S		4326
 <p>Cepex enclosure, deep black as panel mounted receptacle, for installation of RJ45 data port sockets, 2 keys, identical lock: Part no. + Index "G"</p> <p>IP44 Std. Pack: 5</p>	METZ Connect	E-DAT module	2 x 41455	4345 ³⁾

- 1) Cepex enclosures also suited for data modules of Telegärtner (AMJ 45 Up/O, cat.6a) and Nexans (LANmark-6 Snap-in Connector with fixing ring Modular Outlet 50).
- 2) Cepex enclosures also suited for the connection modules Telegärtner (AMJ/UMJ cat.6+, Setec (XKJ), Corning (FutureCOM S10TENE Keystone), Dätwyler (KS-T6A, MS-K, PS-GG45), Rutenbeck (UM real cat.6a, A), LEONI MegaLine, Keystone.
- 3) Cepex enclosures also suited for LEONI MegaLine.

* The data inserts/modules CommScope CO Plus are not part of the MENNEKES delivery program!

ENERGY AND DATA



Overview of mounting options for RJ45 modules in empty Cepex enclosures.

RJ45 modules and Keystones			Cepex panel mounted receptacle										Cepex surface-mounted receptacle						
Brand	Type	Part no. data module	Part no. enclosure Light grey (RAL 7035)				Part no. enclosure Pure white (RAL 9010)				Part no. enclosure Deep black (RAL 9005)	Part no. enclosure Grey (RAL 9006)	Part no. enclosure Light grey (RAL 7035)						
			4322	4342	4362	4377*	4304	4324	4344	4364	4345	4326	4300	4320	4340	4350	4360	4370	4375*
CommScope	Jack				•					•							•		
CommScope	CO Plus																	•	
Telegärtner	AMJ 45 Up/O						•						•			•			
Telegärtner	AMJ/UMJ module					•													•
Nexans	LANmark connector						•						•			•			
METZ Connect	E-DAT module	41455		•					•		•				•				
Rutenbeck	iso-8/8 UPOS	41492	•					•				•		•					
Rutenbeck	UM real					•													•
TKM	KDMF	41452					•						•						
Reichle & De-Massari	Module Real 10	25056				•													•
Setec	XXJ					•													•
Corning	FutureCom					•													•
Dätwyler	KS-T6A					•													•
LEONI	MegaLine			•		•			•		•				•				•

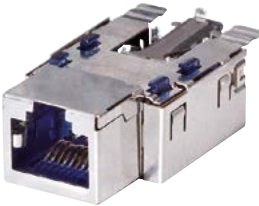

* Keystones

Our keystone-variations can be fitted with **supplier independent** modules. Beside RJ45 modules a large variety of electrical and optical connections for data transmission can be fitted.

ENERGY AND DATA

		Part no.
 <p>Data module METZ Connect, type: RJ45 connection module 270° (type E-DAT module 8(8) jack cat.6), suitable for Cepex data port sockets, part no. 4340, 4342, 4344, strain relief via snap-in clip directly on the "loading piece"</p> <p>Std. Pack: 20</p>		41455
 <p>Data module Reichle & De-Massari, type: data port sockets insert Real 10, Cat.6, screened, including frame for snap-in, fits Cepex data port receptacle, part no. 4375 and variants</p> <p>Std. Pack: 10</p>		25056
 <p>Data module Rutenbeck, type: data port insert 2 x RJ45, Cat.6a, (type UPOS), suitable for Cepex data port sockets, Part no. 4320 and versions</p> <p>Std. Pack: 10</p>		41492



ENERGY AND DATA

		Part no.
 <p>Data module TKM, type: data port insert 2 x RJ45, Cat.6, (type KDMF), suitable for Cepex data port sockets, Part no. 4300 and versions</p> <p>Std. Pack: 10</p>	41452	
	 <p>Data module for Cepex data port receptacles, RJ45 connection module, type E-DAT module connector 8(8) 90°, cat.6 (recommended for improved cable routing)</p> <p>Std. Pack: 10</p>	25042

ENERGY AND DATA

Pre-wired for installation, IP44, enclosure front cover light grey RAL 7035, hinged to the side (except enclosure size 130 x 225 mm and 650 x 112.5 mm). Fusing behind a transparent cover.
[Drawings and dimensions can be found here.](#)



PRODUCT INFORMATION

	CEE receptacles	Data port sockets	Receptacles SCHUKO®	Fusing	Connection	Connection and load values	Enclosure size (H x W)	Part no.
		1 Cepex RJ45, 2 fold Cat.6	2 SCHUKO® 16 A, 230 V	1 RCD 25 A, 2 p, 0.03 A 2 MCB's 16 A, 1 p, C	For 1 cable up to 3 x 10 mm ²	Pre-fuse max. 25 A InA 25 A RDF 1	260 x 225 mm	921312
	CEE receptacles	Data port sockets	Receptacles SCHUKO®	Fusing	Connection	Connection and load values	Enclosure size (H x W)	Part no.
	1 CEE 16 A, 5 p, 400 V	1 Cepex RJ45, 2 fold Cat.6	3 SCHUKO® 16 A, 230 V		For 1 cable up to 5 x 10 mm ²	Pre-fuse max. 16 A InA 16 A	650 x 112,5 mm	960005

ENERGY AND DATA

Pre-wired for installation, IP44, enclosure front cover light grey RAL 7035, hinged to the side (except enclosure size 130 x 225 mm and 650 x 112.5 mm). Fusing behind a transparent cover.
[Drawings and dimensions can be found here.](#)

PRODUCT INFORMATION

	CEE receptacles	Data port sockets	Receptacles SCHUKO®	Fusing	Connection	Connection and load values	Enclosure size	Part no.
	1 CEE 16 A, 5 p, 400 V	1 Cepex RJ45, 2 fold Cat.6	2 SCHUKO® 16 A, 230 V	1 RCD 40 A, 4 p, 0.03 A	For 1 cable up to 5 x 10 mm ²	Pre-fuse max. 16 A InA 16 A	650 x 112,5 mm (H x W)	960340
	CEE receptacles 1 CEE 32 A, 5 p, 400 V 1 CEE 16 A, 5 p, 400 V	2 Cepex RJ45, 2 fold Cat.6	2 SCHUKO® 16 A, 230 V	1 RCD 40 A, 4 p, 0.03 A 1 MCB 32 A, 3 p, C 1 MCB 16 A, 3 p, C 2 MCB's 16 A, 1 p, C	For 2 cables up to 5 x 25 mm ²	Pre-fuse max. 40 A InA 40 A RDF 1	520 x 225 mm (H x W)	940018

MENNEKES network distributor.

With the new industrial network distributor from the AMAXX family, MENNEKES offers a product for the expansion of network solutions.

By using a robust plastic enclosure, the installation of standard network components is possible in more demanding environments, such as those that prevail in trade and industry, with regard to protection class, mechanical influences or similar factors.

Existing networks can thus be quickly expanded, while smaller networks can easily be rebuilt. The user can act freely in the selection of active network components and Keystones. Hence the preferred switches or routers can be easily and safely attached to the integrated mounting plate. The patch panel for mounting up to eight Keystones can be equipped with RJ45 sockets or other inserts.

Two SCHUKO® receptacles integrated into the enclosure are used for the power supply of the active network components. Another advantage for the user: After the power supply has been connected by the qualified electrician, the further equipping and manipulation of the enclosure can be performed by laymen in the field of electrical technology.

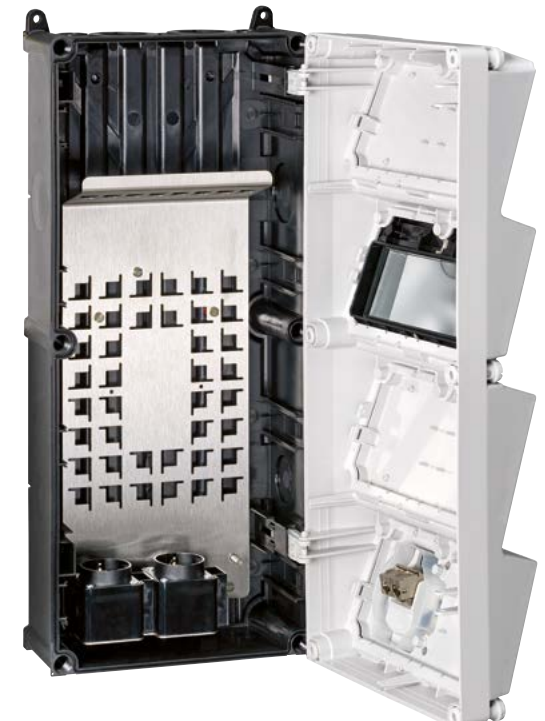

ENERGY AND DATA



Protection type IP44.

Pre-wired for installation, enclosure front cover light grey RAL 7035, yellow (GE) RAL 1021 also available on request. Enclosure hinged to the side.

PRODUCT INFORMATION

	Title	Fitted with	Enclosure size	Part no.
	Network distributor	Patch and mounting panel with threaded ground bolt M6 for the optional connection of an external ground conductor 2 SCHUKO® receptacles for the power supply of active network components 1 Cepex data port socket (deep black RAL 9005) with 2 RJ45 right angle connector modules for direct connection of patch cables 4 Velcro connectors for fastening installed components on the base plate 2 screw fittings M 40 with multiple seal, 6 openings for a cable diameter of 6-9 mm including 5 each blanking plugs 1 screw fitting M 20 1 screw set	520 x 225 mm (H x W)	25405

ENERGY AND DATA

	<p>Title</p> <p>AMAXX cable gland set</p>	<p>Fitted with</p> <p>enclosed with each media distributor Deep black RAL 9005, 2 screw fittings M 40 2 multiple seals with 6 openings for a cable diameter of 6-9 mm including each 5 blind plugs 1 screw fitting M 20</p>
	<p>Title</p> <p>Velcro connector</p>	<p>Fitted with</p> <p>enclosed with each media distributor Set of 4 Velcro connectors for fastening installed components on the base plate</p>

Plugs and sockets for reefer containers On ships and in terminals.

AM-TOP plugs and connectors.

Stable enclosure consisting of one part. The teeth on the cable gland secure a safe grip and protect against loosening. The cable gland serves as an anti-bend protection for the cables at the same time.



**380-
440V**

32 A

3 h

3 p+ 

Plugs and sockets for reefer containers On ships and in terminals.

Wall mounted receptacles, switched and interlocked.

Wall mounted receptacles, switched and interlocked. Receptacles with the patented, mechanical DUO-interlocking ensure that the receptacle can only be switched when inserting a plug.



 Search

Receptacle combinations with receptacles, switched and interlocked



 You can find more information on our website

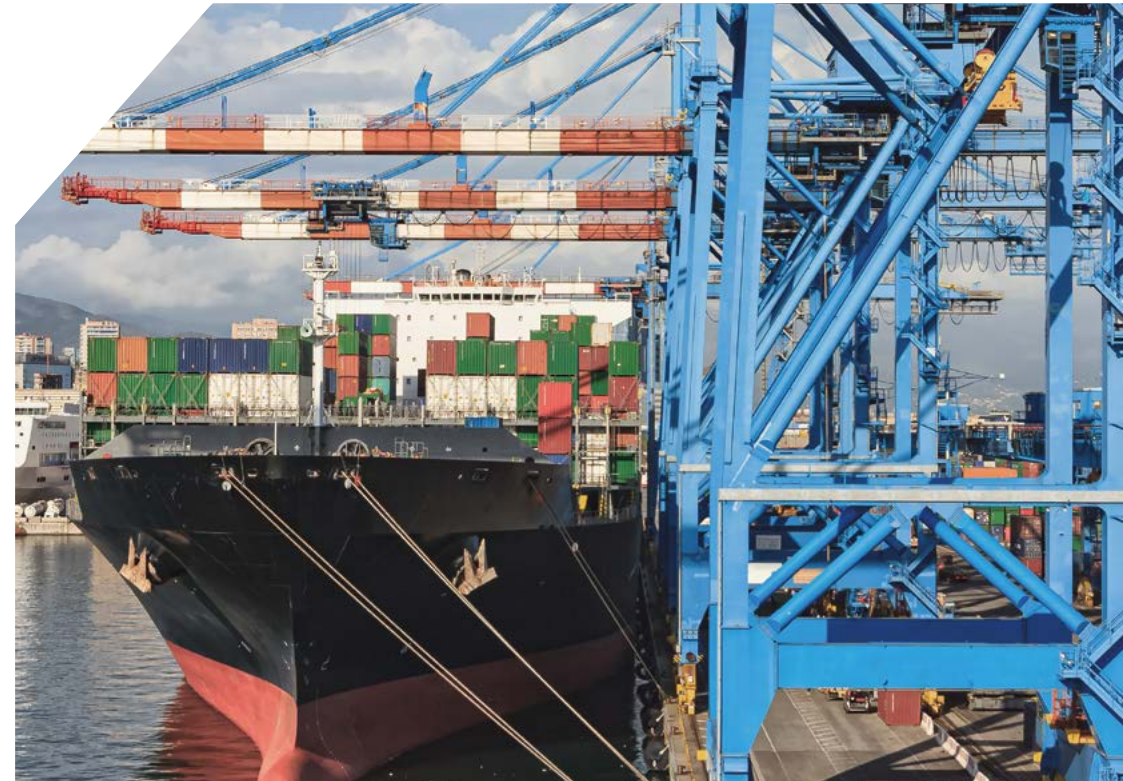

 Index

Plugs and sockets for reefer containers On ships and in terminals.

How many container plugs do you throw away each year?

You know the situation: during the pre-trip inspection before shipping, container plugs have to be replaced with a significant amount of time spent because they no longer comply with regulations. Why? Because the coding nose was cut off to use the plug in 4-pin sockets designed for 6h. On average one third of all container plugs go to waste early, because incorrect connection without a coding nose can lead to overloading of the components.

MENNEKES has the solution!

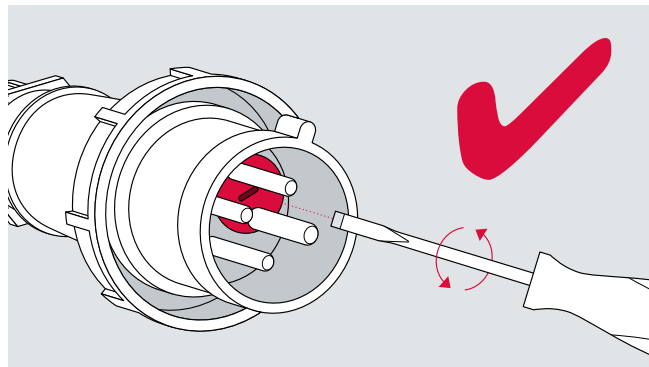
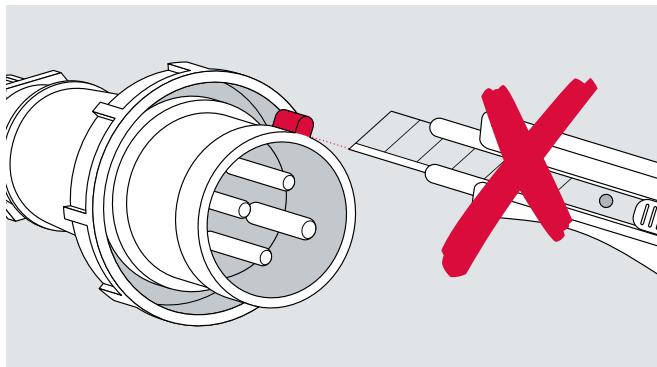

Our new container plug with PE inverter now fits into any 4-pin socket designed for 3h or 6h, as the time coding according to IEC 60309 can be easily adjusted to either of the two codings with a screwdriver. No one will need to cut off the coding nose anymore! This saves you time and money and ensures safe operation.

The new container plug is housed in the enclosure of our standard plug – in the proven MENNEKES quality, produced in the millions and field-tested for years.







Ground contact at 3 o'clock position according to IEC 60309-2, EN IEC 60309-2, DIN EN IEC 60309-2 (VDE 0623-2), DUO-Interlock to IEC 60309-4, EN IEC 60309-4, DIN EN IEC 60309-4 (VDE 0623-3).  Highly resistant to chemicals. Other versions available on request.

PRODUCT INFORMATION

		A	P	380 - 440 V 50 a. 60 Hz 4 p 3 h
	<p>Wall mounted receptacle highly resistant to chemicals, with highly heat resistant contact carrier, nickel plated contacts, two external fixing points, receptacles are designed for adding an auxiliary contact switch, enclosure can be turned 180°</p> <p>IP67 Std. Pack: 10</p>	32	4	9562
NEW 	<p>Wall mounted receptacle DUOi R LED voltage indicator, pre-wired for installation, X-CONTACT, highly heat resistant contact carrier, nickel plated contacts, sealed against dust, temporary submersion and high-pressure cleaning switched, mechanical DUO-interlock, 3 pole switch IP67 / IP69 Std. Pack: 1</p>	32	4	5714403G
	<p>Wall mounted receptacle R pre-wired for installation, X-CONTACT, switched, mechanical DUO-interlock, highly heat resistant contact carrier, nickel plated contacts, 3 pole switch, receptacles can be padlocked</p> <p>IP67 Std. Pack: 1</p>	32	4	5704403G



Ground contact at 3 o'clock position according to IEC 60309-2, EN IEC 60309-2, DIN EN IEC 60309-2 (VDE 0623-2), DUO-Interlock to IEC 60309-4, EN IEC 60309-4, DIN EN IEC 60309-4 (VDE 0623-3).  Highly resistant to chemicals. Other versions available on request.

PRODUCT INFORMATION

		A	P	380 - 440 V 50 a. 60 Hz 4 p 3 h
	<p>Wall mounted receptacle highly heat resistant contact carrier, nickel plated contacts, switched, with mechanical DUO-interlock, DIN rail, receptacles can be padlocked</p> <p> IP67 Std. Pack: 2</p>	32	4	5946A
	<p>Panel mounted receptacle highly heat resistant contact carrier, nickel plated contacts, flange straight</p> <p>IP67 Std. Pack: 10</p>	32	4	2123A
	<p>Panel mounted receptacle switched, with mechanical DUO-interlock, highly heat resistant contact carrier, nickel plated contacts, horizontal design, with load break switch KH32 3 p</p> <p>IP67 Std. Pack: 5</p>	32	4	7538



Ground contact at 3 o'clock position according to IEC 60309-2, EN IEC 60309-2, DIN EN IEC 60309-2 (VDE 0623-2). Other versions available on request.

PRODUCT INFORMATION

		A	P	380 - 440 V 50 a. 60 Hz 4 p 3 h
	<p>Plug AM-TOP highly heat resistant contact carrier, nickel plated contacts, single part body, cable gland and sealing, strain relief and protection against kinking</p> <p>IP67 Std. Pack: 10</p>	32	4	2175B
	<p>PE Inverter AM-TOP single part body, highly heat resistant contact carrier, nickel plated contacts, cable gland and sealing, with rotor to enable changing the clock position from 32 A 4 p 3 h 400 V to 32 A 4 p 6 h 400 V</p> <p>IP67 Std. Pack: 10</p>	32	4	2176
	<p>Phase sequence test plug earthing contact in the 3 o'clock position</p> <p>IP44 Std. Pack: 5</p>	32	4	3718

Ground contact at 3 o'clock position according to IEC 60309-2, EN IEC 60309-2, DIN EN IEC 60309-2 (VDE 0623-2). Other versions available on request.

PRODUCT INFORMATION

		A	P	380 - 440 V 50 a. 60 Hz 4 p 3 h
	<p>Panel mounted inlet with highly heat resistant contact carrier, nickel plated contacts, with hinged lid</p> <p>IP67 Std. Pack:10</p>	32	4	2692
	<p>Connector AM-TOP highly heat resistant contact carrier, nickel plated contacts, single part body, cable gland and sealing, strain relief and protection against kinking</p> <p>IP67 Std. Pack: 10</p>	32	4	2177A
	<p>Holder for plugs 32 A, 4 p</p> <p>Std. Pack: 5</p>			<p>Part no. 41342</p>

Protection type IP67

Low voltage switchgear and control gear assembly according to IEC 61439-3, EN IEC 61439-3. Receptacles with ground contact at 3 o'clock position according to IEC 60309-2, EN IEC 60309-2, DIN EN IEC 60309-2 (VDE 0623-2), DUO-Interlock to IEC 60309-4, EN IEC 60309-4, DIN EN IEC 60309-4 (VDE 0623-3). Other versions available on request.

Receptacles switched, with mechanical DUO interlock with highly heat resistant contact carrier and nickel plated contacts. [Drawings and dimensions can be found here.](#)



It is self-evident for us to offer customized solutions which are especially made for your demand. Please contact us!

PRODUCT INFORMATION

	<p>CEE receptacles</p> <p>3 CEE 32 A, 4 p, 380-440 V, 3 h For reefer containers, switched, with mechanical DUO-interlock</p>	<p>CEE receptacles</p>	<p>Receptacles SCHUKO®</p>	<p>Fusing</p> <p>3 MCB's 32 A, 3 p, C 1 earth bolt M 10, V2A</p>	<p>Connection</p> <p>For 1 cable up to 5 x 25 mm²</p>	<p>Connection and load values</p> <p>Pre-fuse max. 100 A InA 58 A RDF 0.6</p>	<p>Enclosure size</p> <p>520 x 225 mm (H x W)</p>	<p>Part no.</p> <p>940027</p>
---	---	-------------------------------	-----------------------------------	---	---	--	--	---



FOR REEFER CONTAINERS **TM FOR MILITARY PURPOSE**

to IEC 60309-2, EN IEC 60309-2, DIN EN IEC 60309-2 (VDE 0623-2). Color: Bronze green (RAL 6031). The supplement for Defense Equipment No. 96919-... can be found under the respective MENNEKES part number. Other voltages and frequencies available on request.

	A	P	230 V		400 V	400-460 V	>50 - 500 V	
			50 a. 60 Hz		50 a. 60 Hz	50 a. 60 Hz	300-500 Hz	
			3 p	5 p	5 p	5 p	3 p	5 p
			6 h	9 h	6 h	11 h	2 h	2 h
 <p>Panel mounted receptacle TM highly heat resistant contact carrier, nickel plated contacts, straight, (form AS)</p> <p>IP67 Std. Pack: 10/5</p>	16	3	22928 AS013					
	16	5			20458 AS001			
	32	3	23293A AS042					
	32	5			20459 AS005			
	63	5			20460 AS009			
 <p>Panel mounted receptacle TM X-CONTACT, highly heat resistant contact carrier, nickel plated contacts, straight, (form AS)</p> <p>IP67 Std. Pack: 5</p>	125	5			23432 AS014			
 <p>Plug TM highly heat resistant contact carrier, nickel plated contacts, with protective cap, (form CP)</p> <p>IP67 Std. Pack: 10</p>	16	3	24660 CP017					
	16	5			24670 CP001			
	32	3	24760 CP042					
	32	5			24770 CP005			



FOR REEFER CONTAINERS **TM FOR MILITARY PURPOSE**

to IEC 60309-2, EN IEC 60309-2, DIN EN IEC 60309-2 (VDE 0623-2). Color: Bronze green (RAL 6031). The supplement for Defense Equipment No. 96919-... can be found under the respective MENNEKES part number. Other voltages and frequencies available on request.



	A	P	230 V		400 V	400-460 V	>50 - 500 V	
			50 a. 60 Hz		50 a. 60 Hz	50 a. 60 Hz	300-500 Hz	
			3 p	5 p	5 p	5 p	3 p	5 p
			6 h	9 h	6 h	11 h	2 h	2 h
 <p>Plug PowerTOP TM frame terminals, highly heat resistant contact carrier, nickel plated contacts, cable gland and external cable grip, with protective cap, (form CP)</p> <p>IP67 Std. Pack: 5</p>	63	5			24870 CP009			
	125	5			24970 CP013			
 <p>Panel mounted inlet TM highly heat resistant contact carrier, nickel plated contact, with protective cap, (form BP)</p> <p>IP67 Std. Pack: 10/5</p>	16	3			24210 BP013			
	16	5			20461 BP001			
	32	3			23249 BP042			
	32	5			20462 BP005			
	63	5			20463 BP009			
 <p>Panel mounted inlet TM highly heat resistant contact carrier, nickel plated contacts, with protective cap, (form AP)</p> <p>IP67 Std. Pack: 5</p>	125	5			23433			

FOR REEFER CONTAINERS **TM FOR MILITARY PURPOSE**



to IEC 60309-2, EN IEC 60309-2, DIN EN IEC 60309-2 (VDE 0623-2). Color: Bronze green (RAL 6031). The supplement for Defense Equipment No. 96919-... can be found under the respective MENNEKES part number. Other voltages and frequencies available on request.

	A	P	230 V		400 V	400-460 V	>50 - 500 V	
			50 a. 60 Hz		50 a. 60 Hz	50 a. 60 Hz	300-500 Hz	
			3 p	5 p	5 p	5 p	3 p	5 p
			6 h	9 h	6 h	11 h	2 h	2 h
 <p>Phase inverter TM highly heat resistant contact carrier, nickel plated contacts, with protective cap, (form CP)</p> <p>IP67 Std. Pack: 10</p>	16	5			24674 CP057			
	32	5			24774 CP058			
 <p>Connector AM-TOP TM with highly heat resistant contact carrier, nickel plated contacts, with protective cap, (form DS)</p> <p>IP67 Std. Pack: 10</p>	16	3	24675 DS017					
	16	5			24685 DS001			
	32	3	24775 DS042					
	32	5			24785 DS005			
 <p>Connector PowerTOP Xtra TM frame terminals, X-CONTACT, rubberised grip area, highly heat resistant contact carrier, nickel plated contacts, cable gland and external cable grip, strain relief and protection against kinking, enclosure with thread lock, two safety slides, (form DS)</p> <p>IP67 Std. Pack: 5</p>	63	5			24885 DS009			
	125	5			24985 DS013			

to DIN 49442/43 und DIN VDE 0620. Color: Bronze green (RAL 6031). The supplement for Defense Equipment No. 96919-... can be found under the respective MENNEKES part number.

		A	P	230 V
	<p>Panel mounted receptacle SCHUKO® TM bayonet ring lid attached by a strap, with oval flange, two fixing holes, form BS, connecting protective cap</p> <p>IP68 Std. Pack: 10</p>	16	2 p+E	<p>17039 BS001</p>
	<p>Panel mounted receptacle SCHUKO® TM bayonet lock lid attached by a strap, rectangular flange, (form AS), connecting protective caps</p> <p>IP68 Std. Pack: 10</p>	16	2 p+E	<p>17021 AS001</p>
	<p>Plug SCHUKO® TM with double PE-conductor acc. to german and french-belgian standard, with bayonet ring, protective cap attached by a strap, for cables up to 3 x 2.5 mm² up to H07RN-F, (form CP)</p> <p>IP68 Std. Pack: 5</p>	16	2 p+E	<p>10829 CP001</p>

to DIN 49442/43 und DIN VDE 0620. Color: Bronze green (RAL 6031). The supplement for Defense Equipment No. 96919-... can be found under the respective MENNEKES part number.

		A	P	230 V
 <p>Panel mounted inlet SCHUKO® TM with double PE-conductor acc. to german and french-belgian standard, with bayonet ring, protective cap attached by a strap, (form AP)</p> <p>IP68 Std. Pack: 10</p>	16	2 p+E	10853 AP001	
 <p>Connector SCHUKO® TM bayonet lid attached by strap, for cables up to 3 x 2.5 mm², up to H07RN-F, (form DS)</p> <p>IP68 Std. Pack: 5</p>	16	2 p+E	10834 DS001	

References



BMW motorcycle plant,
Berlin, Germany



**KORDSA GLOBAL A.S., Industrial Yarn and Cord
Factory,** Izmit, Turkey



Formula 1 circuit,
Manama, Bahrain



**Shanghai International Circuit (Formula 1 Race
Course),** Shanghai, China



Yas Marina Circuit (Formula 1 Race Course),
Abu Dhabi, UAE



Football Stadium „Signal Iduna Park“,
Dortmund, Germany



Olympia Stadium,
Berlin, Germany



Linea 1, Metro de Lima,
Lima, Peru

References



Container Terminal,
Le Havre, France



WIKUS-Sägenfabrik (Sawing factory),
Spangenberg, Germany



Container Terminal,
Altenwerder, Germany



Ceramica Marca Corona,
Sassuolo, Italy



Bauernmarkt (Market Square),
Hannover, Germany



Brunnenmarkt (Market Square),
Vienna, Austria



Barbara Erzbergbau GmbH (Underground Ore Mining),
Porta Westfalica, Germany



Internet Data Center,
South Korea

Regulations and standards

While correct to the best of our knowledge, the information we provide with respect to laws and regulations is in no way binding. Such information is provided purely by way of assistance and makes no claim to completeness. The nature and composition of our appliances are exclusively as quoted in the product description to which the part numbers refer directly.

Installation guidelines

It is best to proceed carefully with the installation and the use of electrical devices. The valid directives and standards, as well as the legal accident prevention regulations must be complied with. The installer is responsible for compliance with the respective regulations.

MENNEKES CEE plugs and sockets conform to the following standards and regulations:

IEC 60309-1

IEC 60309-2

EN IEC 60309-1

EN IEC 60309-2

DIN EN IEC 60309-1 (VDE 0623-1)

DIN EN IEC 60309-2 (VDE 0623-2)

Applications

CEE plugs and sockets can and, under certain circumstances, must be used in industry, in commerce, in agriculture, in parks, in damp and wet environments, outdoors, on building sites, in caravans, on boats and yachts, on camp sites, for dockside power supply installations (marinas), on works premises where there is a fire hazard, at markets and fairground booths and for trailers and mobile homes.

Using CEE plugs and sockets will usually enable the planners and builders of electrical installations to comply with the „regulations for the construction of low voltage systems as per DIN VDE 0100“.

Enclosure material

Plastic material

MENNEKES generally uses high-grade plastic material with the following excellent properties: Excellent electrical insulation, break-proof, wearresistant, abrasion-resistant, dimensionally stable, self-extinguishing, heat-resistant, cold-resistant, stabilised against aging, resistant to seawater, oil, and petrol. For use in industrial premises or place of work where the use of chemicals or other aggressive substances makes it necessary to use other plastic materials, MENNEKES offers products with increased stability against fuel, oil and grease, diluted acids and alkali, cleaner and the most aqueous salt solutions. These products are marked in the catalogue with . Products made of this plastic combine high mechanical, thermal and electrical properties with excellent dimensional stability and resistance to chemicals and are fit for action in chemical plants, in refineries, in the food processing industry, in washdown areas and so on.

Regulations and standards

Solid rubber

Solid rubber blends are preferably used wherever products are exposed to high mechanical and/or chemical loads. Solid rubber excels by its outstanding dimensional stability; it is largely resistant to acid and lye and has a high resistance to breakdown and leakage current. Products made from solid rubber blends, e.g. MENNEKES EverGUM, are resistant to weather and ageing. Under UV radiation, colour pigments may fade with time. This is inevitable even to the latest state of the art yet it does not compromise the function in any way.

Stainless steel

Our high-quality stainless steel products are ideally suited for continuous use in buildings and outdoors. There is a potential risk of corrosion in open air and indoor swimming pools, in coastal regions, offshore and in industrial areas with high air pollution. Subject to location and climatic conditions discoloration and corrosion can arise. Through specific cleaning and maintenance procedures, impairments of the surface can be reduced or avoided. In particularly aggressive ambient conditions we recommend the use of special stainless steels or coating the surfaces to further increase corrosion resistance.

Contact material, small parts

Female and male contacts are made of brass; screws, springs, etc. are made of rust-proof material or surface-coated steel.

Characteristics of CEE plugs and sockets

MENNEKES CEE plugs and sockets are distinguished by the following features, which keep maintenance costs to a minimum:

- Easy to install
- Wiring space easily accessible
- Power screwdrivers can be used for installation
- Mostly fitted with Pozidriv screws (size 2)
- High contact pressure
- Low effort required for insertion and withdrawal
- Low transition resistance
- Easy-to-grip plugs

Regulations and standards

Application

CEE plugs and sockets with operating voltages up to 1000 V DC or AC, frequencies up to 500 Hz and rated currents up to 800 A, including plugs and receptacles for low voltage systems have become the standard all over the world. Basically suitable for indoor and outdoor applications in industry, they are also used on building sites, farms, commercial premises, for caravans, mobile homes, boats, yachts and in households. CEE plugs and sockets are polarised and non-reversible.

Ambient temperature

CEE plugs and sockets are suitable for ambient temperatures between -25 °C up to +40 °C.

Low voltage directive 2014/35/EU

CEE plugs and sockets are subject to the EC low voltage directive and must therefore be provided with the CE mark to ensure free traffic of goods within the EU. A manufacturer's declaration is available on request.

Declaration of Conformity

Current plugs and sockets have been tested by the VDE Test and Certification Institute in Offenbach, Germany. Furthermore, various other certificates from international inspection authorities have been obtained. A copy of test certificates is available on request.

The CE mark is not a compliance mark. MENNEKES CEE plugs and sockets satisfy the requirements specified in the low voltage directive and the device and/or the packaging bears the „CE“ mark „“.

Cable glands

Metric	Typical sealing area	Typical capacity of terminal	Metric	Typical sealing area	Typical capacity of terminal
M 12	2.5 - 6.5 mm	3.0 - 6.5 mm	M 32	14.0 - 25.0 mm	17.0 - 25.0 mm
M 16	2.5 - 8.0 mm	3.5 - 8.0 mm	M 40	18.0 - 32.0 mm	20.0 - 32.0 mm
M 20	5.0 - 12.0 mm	6.0 - 12.0 mm	M 50	24.0 - 38.0 mm	26.0 - 38.0 mm
M 25	9.0 - 18.0 mm	12.0 - 18.0 mm	M 63	30.0 - 44.0 mm	30.0 - 44.0 mm

Regulations and standards

Standard for low voltage switchgear and control gear assemblies - IEC 61439

The standard IEC 61439 replaces IEC 60439 and describes the design and the test specifications for low voltage switchgear and control gear assemblies. The new standard has influence on the distribution of electrical energy in industry, the domestic electrical installation and on construction sites.

In 2012, the restructuring and revision of the safety requirements for low voltage switchgear was finalized with publication of the standard, IEC 61439-1:2012. The preceding standard, IEC 60439-1 will be replaced by IEC 61439-1:2012. The former Standard IEC 60439 was replaced by IEC 61439-1:2012 in September 2014. For all switchgear assemblies commissioned after this date, planning and documentation must be in accordance with IEC 61439-1: 2012 and its parts.

The purpose of this standard is the harmonisation of most of the general regulations and requirements for low voltage switchgear and control gear assemblies to achieve uniform requirements and verifications for switchgear and control assemblies and to avoid the necessity of verifications in accordance with other standards. All requirements of the different switchgear and control gear assemblies have been combined in this fundamental standard, together with topics of broad interest and application, e.g heating, insulation properties, etc.

In the future two main standards will be required for each design of a low voltage switchgear and control gear assembly:

- The basic standard that is referenced as „Part 1“ in the specific standards;
- The applicable parts 2 to 7 of the switchgear and control gear assembly standard that deal with the particularities of the application.

The IEC 61439 consists of the following parts:

IEC ...	Replaces IEC ...
61439-1: General definitions	60439-1
61439-2: Power switchgear and control gear assemblies (PSC switchgear combinations)	60439-1
61439-3: Installation distributor for operation by laymen (DBO)	60439-3
61439-4: Special requirements for construction power distribution boards (BV)	60439-4
61439-5: Switchgear combinations in public power distribution networks	60439-5
61439-6: Busbar trunking systems (busways)	60439-2
61439-7: Switchgear combinations for specific applications such as marinas, campsites, marketplaces, Charging stations for electric vehicles	60439-7
IEC TR 61439-0: Guide for the specification of switchgear and controlgear assemblies	

Regulations and standards

Requirements in this standard, which are object of an agreement between manufacturer of the switchgear and control gear assemblies and user, are summarized on the following pages. This listing facilitates provision of information concerning basic conditions and supplemental user definitions.

Design verification

Additionally to the type verification, the producer has to provide an article proof which guarantees a correct set-up acc. to the norm, excludes material failures and the compliance with electrical safety requirements.

Definition – „original manufacturer“ and „manufacturer of the switchgear and control gear assembly“

Original manufacturer

Organisation / enterprise that executed the original design and the associated verifications in accordance with the standard.

Manufacturer of the switchgear and control gear assembly

Organisation that completes a device and assembles it into a functional unit. The manufacturer is responsible for piece verification and thus for the product (Declaration of Conformity).

Significance for MENNEKES products:

For pre-wired devices MENNEKES is simultaneously the original manufacturer and the manufacturer. The responsibility and provision of verifications rest with us. We cannot declare partially wired devices that we manufacture as standard compliant. In this case the „finishing entity“ becomes the manufacturer and must declare conformity. It is required to forward information to this organisation so that the device ultimately can get a „Declaration of Conformity“.

Heating

The max. ambient temperature is +40 °C.

The average value of the ambient temperature over a period of 24 hours must not be higher than +35 °C.

The verification of heating can be provided through various methods. Through testing of the switchgear and control gear combination, or through derivation of a known reference, and through an expert assessment, e.g in accordance with applicable design rules. Regardless of the method that is selected to determine the heat and thus the maximum current load of the combination, compliance with the appropriate temperature limit values must be ensured.

The switchgear and control gear assembly and its electrical circuits must be capable of bearing their rated currents under defined conditions and the rated values of the components, their suitability and application must be taken into account, without exceeding limit values specified in IEC 61439-1 Table 6, Part 1. The limit temperatures in table 6 apply for the average ambient temperature of +35 °C.

► The limit temperatures of the installed equipment must be taken into account!

Regulations and standards

Heating – replacement of components

A device/component may only be replaced through a similar, identically constructed device of a series other than the series used in the verification, if the power loss, and thus the heating of the connections is less than or equal to that of the device that is being replaced.

Load of the largest electric circuit and of all outgoing circuits individually with rated current

The requirement of IEC 61439 is, that all electric circuits must be individually capable to carry their rated current, without exceeding temperature limit values in the process. If additional power circuits are added, a rated load factor can be set.

Rated values I_{nA} , I_{nc} , RDF

• Standard definition I_{nA}

The rated current of the switchgear and control gear assembly, I_{nA} , is the total current that the main busbar can distribute in the respective installation of the assembly, without exceeding the temperature limit values mentioned in IEC 61439-1 section 9.2!

The current, I_{nA} , is considered to be the maximum current that the assembly can distribute via its outgoing circuits at 100 % continuous duty (CD).

• Standard definition I_{nc}

The rated current of an electric circuit is the value of the current that can be carried by this electric circuit under standard operating conditions when it is operated alone. The assembly must be capable of carrying this current without exceeding the max. temperature limits of the individual components specified in IEC 61439-1 section 9.2.

• Standard definition – rated diversity factor RDF

The RDF is the specified percentage value of the rated current with which the (individual) outgoing circuits I_{nc} of a switchgear and control gear assembly can be continuously and simultaneously used with due consideration of the opposing thermal influences. In this process the I_{nA} must not be exceeded.

Regulations and standards

Table 101 from IEC 61439-3 Values for assumed load

Number of outgoing circuits	Assumed load factor
2 and 3	0.8
4 and 5	0.7
6, up to and including 9	0.6
10 (and more)	0.5

This table provides guide values, if in doubt the manufacturer's specification always applies.

MENNEKES standard values in accordance with Table C of IEC 61439

The information below represents specified standard values for MENNEKES catalogue assemblies. If there are deviations from this standard or in the case of special project planning, appropriate coordination must take place beforehand between user and manufacturer. These agreements must be arranged between MENNEKES and the user / customer during the quotation phase (prior to production and prior to sale). The table below is a „blank“ that is applicable for approximately 98 % of the MENNEKES devices. Special project planning is not covered by the specifications, and must be separately disclosed by the user prior to project planning. In these special cases, it is required that additional details be considered with the aid of the standards cited and their product sub-standards (see Section 7.2, in Part 1).

Characteristic	Standard value	Normative option	MENNEKES standard
System according to type of earth connection	Design in accordance with the local requirements	TT/TN-C/TN-C-S/IT/TN-S	TN / TT
Rated voltage	In accordance with local installation conditions	max. 1000 V AC or 1500 V DC	400 V AC
Transient overvoltages	determined through the electrical system	Overvoltage category I / II / III / IV	Kat. III / plugs and sockets Kat. II
Occasional overvoltages	min. rated voltage + 1200 V	See Table 8 + 9 or 10 for the values	1890 V (AC)
Rated frequency	In accordance with local installation conditions	DC / 50 Hz / 60 Hz	50 Hz
Short circuit resistance	determined through the system	N + PE max 60 % of the outer conductor values	I_{cc} max. \leq 10 kA

Regulations and standards

Characteristic	Standard value	Normative option	MENNEKES standard
SCPD in the supply	In accordance with local installation conditions	yes / no	no
Coordination between shortcircuit protection devices inside or outside of the switchgear and control gear assembly	In accordance with local installation conditions	present / install / integrate	Item-dependent
Information of loads that could possibly contribute to short-circuit current	No loads are permitted that could possibly contribute to the shortcircuit current	none	none
Type of protection against electric shock – basic protection	Basic protection	Comply with local requirements	Basic protection
Type of protection against electric shock – earth fault protection	Protection against indirect contact / comply with local requirements	Automatic disconnection of the power supply / protective isolation / double or reinforced insulation	Item-dependent
Installation site	Execution of the manufacturer	Indoors / outdoors	Item-dependent
Protection type	Indoors min. IP2x / outdoors min. IP23	IPxx (A-D)	IP44
Protection against mechanical effects		if necessary specification of the IK code (IEC 62262)	Information on request
Resistance to UV radiation		Required for enclosures in outdoor installation	Information on request
Resistance to corrosion	For indoor and outdoor installation	yes / no	Item-dependent
Ambient temperature limit values	Indoors: min. -5 °C Outdoors: min. -25 °C High limit (both): +40 °C max. average value (24 h): +35 °C	none	Standard values! See product for deviations

Regulations and standards

Characteristic	Standard value	Normative option	MENNEKES standard
Highest relative humidity	Indoors: 95 % at -5 °C to +30 °C 70 % at +35 °C 57 % at +40 °C Outdoors: 95 % at -5 °C to +30 °C 70 % at +35 °C 57 % at +40 °C	Indoors: 95 % at -5 °C to +30 °C 70 % at +35 °C 57 % at +40 °C Outdoors: 95 % at -5 °C to +30 °C 70 % at +35 °C 57 % at +40 °C	Standard values! See product for deviations
Pollution degree	Industrial environment 3	1, 2, 3, 4	3
Altitude	≤ 2000 m	Pay attention to the factors	≤ 2000 m
EMC environment	A or B	A / B	B
Special operating conditions (vibration, Ex-area, strong magnetic fields or contamination)	No particular conditions	none	Not defined!
External structural design	in accordance with manufacturer's specifications	Open / closed / standing / in-wall installation & on-wall installation / console	closed
Mobile or stationary	stationary	yes / no	Item-dependent
Dimensions and masses	in accordance with manufacturer's specifications	none	Item-dependent
Type of conductors introduced from outside	in accordance with manufacturer's specifications	Cables / busbar trunking systems	Cables
Materials of the conductors introduced from the outside	Copper	Copper / aluminum	Copper
Cross-sections of the outer conductors, PE, N & PEN conductors	As specified in the standard	none	none

Regulations and standards

Characteristic	Standard value	Normative option	MENNEKES standard
Special requirements imposed on the marking of connections	in accordance with manufacturer's specifications	none	Manufacturer execution
Requirements imposed on storage & transport (type of transport, deviating ambient conditions, max. dimensions, packaging requirements)	Standard of the manufacturer	none	Information on request
Operability (access, activation rights, disconnect)	Easy reachability	Authorized persons, ordinary persons, etc.	Item-dependent
Requirements imposed on accessibility for operation, inspection, maintenance or extension	Inspection, component replacement, extension, maintenance, etc. only by specialized persons (requirement)	none	Inspection, replacement, extension, maintenance, etc. only through specialized persons
Separation of the outgoing electric circuits	in accordance with manufacturer's specifications	Individually / in groups / all	Item-dependent
Type of interior subdivision	in accordance with manufacturer's specifications	Form 1, 2, 3, 4	none
Maximum total load current to be supplied by the switchgear and controlgear assembly (this determines the rated current of the switchgear and controlgear assembly InA (A)).	Manufacturers standard; in accordance with the application	none	Item-dependent
Cross-section ratio between outer conductor and N*	$\varnothing \leq 16 \text{ mm}^2 = 100 \%$ $\varnothing > 16 \text{ mm}^2 = 50 \%$ (min. 16 mm ²)	For currents in N to 50 % of the outer conductors, otherwise a special agreement is necessary!	Outer conductor = neutral conductor cross-section

* MENNEKES designs the size of the Neutral conductor accordingly to the max. allowed current for the phases. For special operating conditions (see IEC 61439, section 7.2 and IEC 61439-1 supplement 1, section 13.5) which relate to the ratio of neutral conductor to outer conductor (alternating current consumption with very low and different cosφ or excessive harmonics in the supply voltage or load current) can lead to a different size relation between neutral conductor to external conductor. This must be announced by the user.

Regulations and standards

Clock positions acc. to IEC 60309-2:2021, table 210, Series I

Position of ground contact sleeve with respect to major keyway for various voltages and frequencies. The colour codes correspond to the nominal voltage.





* for nominal operating voltages and/or frequencies not otherwise covered and for special applications.

** Clock positions not used.

Regulations and standards

Colour coding

If the rated operating voltage is indicated by a colour coding in addition to compulsory markings, such colour coding must be in accordance with IEC 60309-1:2021, table 2:

Rated operating voltage and frequency	Colour code	RAL*
100 to 130 V	yellow 	1021
200 to 250 V	blue 	5007
380 to 480 V	red 	3013
500 to 1.000 V	black 	9005
above 60 to 500 Hz	green 	6010

* RAL determined by MENNEKES

CEE plugs and sockets for rated operating voltages above 50 V

Position of the earth contact

Plugs and sockets with rated voltages above 50 V must have an earth contact. To prevent incorrect insertion, a nose on the plug fits into a keyway in the receptacle, thus ensuring that the earth contact pin or tube is correctly positioned in accordance with the required electrical standard. The earth contact positions for the various frequencies and voltages are assigned a clockface position, in accordance with table 204 taken from IEC 60309-2:2021 (see above).

Regulations and standards

CEE plugs and sockets for rated voltages of up to 50 V (low voltage)

Since no earth contact is required in plugs and sockets of rated voltage up to 50 V, two keyways instead of one are provided the collar. They are accordingly termed the major and minor keyways. The major keyway is always in the 6 o'clock position. Depending on voltages and frequencies, the minor keyway is always in accordance with table 208 taken from IEC 60309-2:2021, standard sheet 2-VIII (and in the following drawings).

Drawing: receptacles and connectors U = 40 to 50 V, 50 to 60 Hz, minor keyway in 12 o'clock position

16/32 A

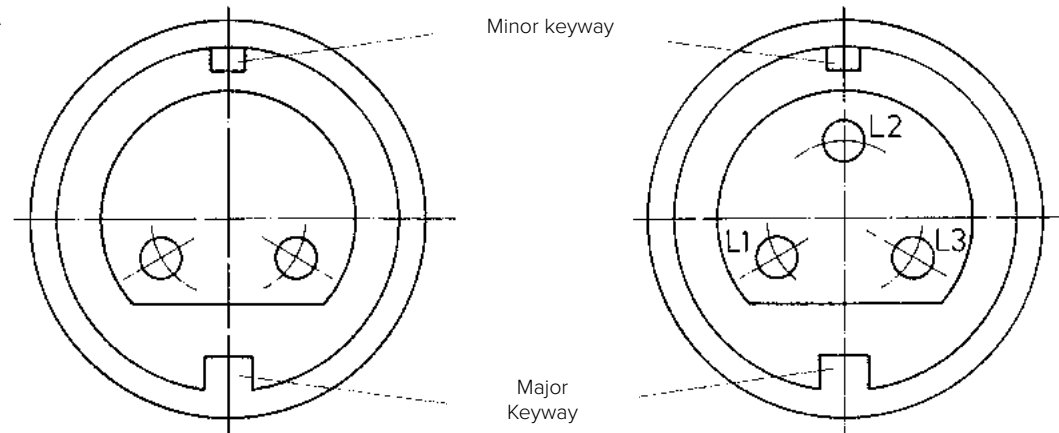



Regulations and standards

Arrangement of the minor keyway (major keyway 6 o'clock) for various voltages and frequencies using clockface positions in accordance with table 208 taken from IEC 60309-2:2021

Rated operating voltage V	Frequency Hz	Clockface position of keyway (major keyway = 6 o'clock)	
20 to 25	50 and 60	no minor keyway	Positions 1 and 9 are reserved for future standards. For design reasons, positions 5, 6 and 7 are not available for use.
40 to 50	50 and 60	12	
20 to 25 and 40 to 50	100 to 200	4	
	300	2	
	400	3	
	> 400 to 500	11	
	DC	10	
25	DC*	8 *for portable electrical incubators – use with 12 V or 24 V direct-current voltage in ambulances or helicopters.	

Colour coding

If the rated operating voltage is indicated by a colour coding in addition to compulsory markings, such colour coding must be in accordance with IEC 60309-1:2021, table 2:

Rated operating voltage	Colour code	RAL*
20 to 25 V	violet 	4001
40 to 50 V	white 	7035

* RAL determined by MENNEKES

Regulations and standards

Interlocks and breaking capacity

Plugs and sockets without an interlock must have an adequate breaking capacity, i.e. it must be possible to insert and withdraw plugs in the manner specified and as often as specified. After testing they must exhibit no damage that would impair further use, and the holes for the plug contacts must not show any significant sign of damage. Receptacles and connectors that do not meet the test requirements for breaking capacity and service characteristics must be fitted with an interlock. An interlock is a mechanical or electrical device which ensures that voltage is only applied to the contacts of a plug once they have been inserted into a receptacle or connector as intended, which prevents a plug being withdrawn with the power switched on or which makes contacts voltage-free before disconnecting. A distinction is made between interlocked plugs and sockets with

- mechanical interlocks
- electrical interlocks.

In the case of receptacles and connectors $\geq 63/60$ A, IEC 60309-2:2021 requires that a distinction is made between products used with or without interlocks. As MENNEKES plugs and sockets have adequate breaking capacity, standard $\geq 63/60$ A versions are fitted with short contact tubes without pilot contact. In the 63 A and 125 A versions, the short contact tubes meet the finger-touch requirements of IEC 60529. Receptacles and connectors 63/60 A for electrical interlocking are fitted with long contact tubes and pilot contact for leading and lagging. The interlock makes up for the lack of finger-touch safety.

Plugs and sockets with mechanical interlocks

Mechanical interlocks for plugs and sockets with a rated operating voltage greater than 50 V must conform to IEC 60309-2:2021, standard sheet 2-V. The mechanical switch of a mechanically interlocked receptacle or connector must not be operational until the proper plug has been inserted. Built-in switches for mechanical interlocking of switched AC receptacles must have a breaking capacity conforming at least to IEC 60947-3, DIN EN IEC 60947-3 (VDE 0660-107), utilisation category AC 22. The breaking capacity must be suitable for the appliance connected.

Plugs and sockets with electrical interlocks

In the case of plugs and sockets $\geq 63/60$ A with a rated operating voltage greater than 50 V intended for electrical interlocking (part no. + index „P“), a built-in pilot contact can be used to switch off power to a receptacle or connector. The requisite switch can either be provided in the receptacle or on the corresponding circuit distribution board. In the case of receptacles with an integrated auxiliary switch fitted behind the pilot tube, the switch is triggered by the pilot pin of the plug. The advantage of this solution is that the pilot tube itself is not live (PCS interlock).

Plugs and sockets for isolating and switching purposes

In accordance with DIN VDE 0100-460, each electrical circuit must be capable of being disconnected from all active conductors of the power supply. This also applies for every piece of electrical equipment, which must be capable of being disconnected from the power supply via an installed or assigned switch. For the term, „disconnect“, the term „isolate“ is also used. As a rule, electrical equipment must be disconnected from the power grid for mechanical and electrical maintenance tasks. According to DIN VDE 0100-537, plugs and sockets isolating all conductors are suitable for the disconnection of power for maintenance purposes if they are able to switch off the load current in the electrical equipment in question. A plug and socket connection is a simple way of satisfying the requirement for „visible isolation“.

Regulations and standards

Shock hazard protection



Shock hazard protection must be achieved in accordance with IEC 60309-1:2021 section 9 by designing plugs and sockets in such a way that, when engaged properly, no live parts of receptacles, connectors, plugs and inlets are exposed so that they may be touched.

It must also be impossible to establish a connection of plugs and connectors while any of the contacts are exposed to touch.

Neutral contact tubes and pilot contacts of receptacles and connectors are deemed to be live parts.

Protection type

Plugs and sockets used to be classified according to the degree of protection against the entry of moisture:

- splashproof → drop in a triangle 
- watertight → 2 drops 

Today, complete IP protection according to IEC 60529, DIN EN 60529 (VDE 0470-1) is specified for plugs and sockets, as they are tested in line with this standard.

IP44 = Protection from solid bodies with a diameter ≥ 1 mm, splashproof

IP67 = Protection from dust ingress, protection against temporary immersion

IP69 = Protection against dust ingress, protection against high pressure and high jet water temperature

IP67 / IP69 = Protection against dust ingress, protection against temporary submersion as well as against high pressure and high jet water temperature

Information on IP protection (IP code) can be found in IEC 60529, DIN EN 60529 (VDE 0470-1).

Having been properly installed, receptacles and connectors must provide the degree of protection defined by the rating, whether the plug is inserted or not.

The protection type for plugs and inlets only applies if they are in contact with the matching piece of the connector or with a fixed cover, if applicable.

CEE plugs and sockets with rated currents of 100/125 A must be IP67.

100/125 A receptacles that are fastened to an enclosure or form a structural unit with the enclosure can be IP44.

Regulations and standards

For receptacles IP67, a bayonet system has been adopted as the standard in order to simplify their use especially under rough working conditions.

The Protection type is indicated on the labels of the devices.

Notice for the use of mobile power distribution boxes:

Please consider when using SCHUKO® receptacles that due to the construction the degree of protection is achieved only when the lid is closed. Otherwise the ingress of water at the ground contact area may not be prevented (see DIN VDE 0620-1).

Degree of protection of SCHUKO® plugs and sockets. Standard change of DIN VDE 0620-1.

The installed data sockets without lid have a degree of protection of IP20 which is reducing the degree of the whole unit accordingly.

For use in mobile devices, in accordance with the current specifications, attachment receptacles that satisfy the IPX4 degree of protection requirements with closed flip-lid cover and with a plugged-in plug in every operating position. Before the standard change in February 2010, the IPX4 degree of protection was considered as fulfilled if the conditions are satisfied with vertical install position of the receptacles. For receptacles for stationary implementation, this also continues to be the case.

Important application instructions concerning the change in the standard.

- The amendment of DIN VDE 0620-1 (March 2013) makes a distinction in the case of IPX4 SCHUKO® receptacles, between stationary and mobile implementation conditions
- SCHUKO® IPX4 receptacles for stationary and mobile implementation conditions differ in their design (mobile with additional sealing collar, stationary unchanged).
- SCHUKO® IPX4 connectors, like mobile SCHUKO® IPX4 receptacles likewise have a supplemental sealing collar.

Attention!

- SCHUKO® plugs > IPX4 when plugged into mobile IPX4 SCHUKO® receptacles or connectors do not achieve adequate contacting due to the design and thus they must not be operated with such receptacles!
- The same applies for AC adapters and angled right angle plugs < IPX4!
- On the appropriate SCHUKO® receptacles or connectors this circumstance is presented with an engraved right angle SCHUKO® plug with IPX4 mark.

Before processing, ensure that the SCHUKO® articles at hand correspond to the implementation conditions for which they are intended.

Notice for the use of mobile power distribution boxes with RJ45 data sockets:











The installed data sockets without lid have a degree of protection of IP20 which is reducing the degree of the whole unit accordingly.

Regulations and standards

IP protection types for enclosures in accordance with IEC 60529, EN 60529, DIN EN 60529 (VDE 0470-1)

1st number of the code:

Protection against the ingress of foreign bodies and shock hazard protection.







Code	Description	Test	Protection against contact with:	Test
0	Enclosure protected against ingress of:			
1	Solid body larger than 50 mm	 Gauge plug diameter Ø 50 mm	Back of hand	 Gauge probe diameter Ø 50 mm
2	Solid body larger than 12.5 mm	 Gauge plug diameter Ø 12.5 mm	Finger	 Jointed metal finger
3	Solid body larger than 2.5 mm	 Gauge plug diameter Ø 2.5 mm	Tool	 Gauge probe diameter Ø 2.5 mm
4	Solid body larger than 1 mm	 Gauge plug diameter Ø 1 mm	Wire	 Gauge probe diameter Ø 1 mm
5	Dust in harmful quantities	 Talc		
6	Dust overall	 Talc		

Regulations and standards

IP protection types for enclosures in accordance with IEC 60529, EN 60529, DIN EN 60529 (VDE 0470-1)

2nd number of the code:

Protection against the ingress of moisture

Code	Description		Code	Description	
	Enclosure protected against ingress of:	Test		Enclosure protected against ingress of:	Test
0			5	Water jet	
1	Drop of water falling vertically		6	Strong water jet	
2	Drop of water falling vertically on enclosure inclined by up to 15°		7	Temporary immersion	
3	Water spray		8	Continuous immersion	By arrangement between manufacturer and user. Extra severe test conditions as compared to code 7
4	Splash water		9	Water at high pressure and steam cleaning	

Terms and conditions

I. Material Conditions, Scope

1. All deliveries, services and offers of the seller shall be exclusively on the basis of these General Terms and Conditions. These shall form an integral part of all contracts concluded by the Seller with its contract partners (hereinafter also referred to as „Principal“ and/or „Buyer“) with respect to the deliveries and services offered by it. They shall apply for all future deliveries, services and offers made or rendered to the Principal, even where such is not separately so agreed.
2. Contrary business terms or purchasing conditions of the Principal or any third party shall not apply, even where the Seller does not expressly reject their application in the individual case. Even where the Seller refer to correspondence containing business terms of the Principal or a third party, this shall not indicate the Seller's acceptance of these terms.
3. The General Terms and Conditions shall only apply with respect to entrepreneurs in the sense of § 14(1) BGB (German Civil Code).

II. Offer and Conclusion of Contract

1. In the absence of any express indication to the contrary, all offers of the Seller shall remain subject to change and shall be non-binding. The Seller shall be able to accept orders within 14 days of their receipt.
2. The order shall be binding upon the Seller (conclusion of contract) once it has provided written confirmation of order or where it begins execution of order.
3. The legal relationship between Seller and Buyer shall be governed exclusively by the terms of the contract of sale they conclude, including these General Terms and Conditions. This contract shall render the agreement between the contract parties in full. Oral warranties given by the Seller before conclusion of this contract shall be legally non-binding and any oral agreements between the contracting parties shall be abrogated and replaced by the written contract, except in the case that such oral agreements expressly state that that they shall remain binding.
4. Supplements and amendments to agreements made, including these General Terms and Conditions, must be made in writing for their validity. Written form shall include fax and text telecommunication, in particular through e-mail, provided that such declarations are confirmed by the receiving contracting party in the same text form.
5. Indications made by the Seller on the object of the delivery or service (e.g. weight, dimensions, utility values, load capacity, tolerance, technical or other service data) as well as corresponding representations of the Seller with respect to these indications (e.g. sketches, illustrations) shall be approximations only unless expressly described in writing by the Seller as binding and/or where the actual purpose of contract require exact agreement with the specific indications. They are not warranted characteristics, but descriptions or features of the delivery or service. Customary deviations and deviations resulting from legal provisions or technical improvements, as well as the replacement of certain components by others of equal quality, shall be permissible insofar as they do not impair the intended contract purpose.
6. The Seller shall retain title and/or copyright in all offers and quotes it makes as well as in all sketches, illustrations, invoices, prospectuses, catalogues, models, tools and other documentation and auxiliary materials. The Buyer shall not make these or their contents available to third parties or make them known to third parties without express approval from the Seller, nor shall it use or reproduce them, either personally or with the help of a third party. At the request of the Seller, the Buyer shall return these objects and shall destroy any copies made where these are no longer required in the ordinary course of business or where negotiations have not resulted in the conclusion of contract. The same shall apply for documents provided by the Buyer to the Seller for implementation of contract. The Seller shall be entitled to make these documents available to third parties charged with making deliveries.
7. Should the Buyer rescind the contract before delivery of the ordered article, the Seller shall be entitled to invoice the Buyer for all costs incurred up to the point of rescission. These costs shall include, inter alia, project planning costs, processing costs for the compilation and supervision of order, manufacture planning costs, costs for goods fabricated etc.. Irrespective of this, the Seller shall also be entitled to demand specific performance.

Terms and conditions

III. Prices, Right to Amend Prices, Conditions of Payment and Consequences of Default, Set Off and Right of Retention

1. The prices shall apply with respect to the service and/or delivery set out in the confirmation of order issued by the Seller. Additional or special services like trainings, issuing certificates etc. shall be invoiced separately.
2. In the absence of any express agreement for a particular currency, prices shall be understood in EUR ex works plus shipping and handling cost (freight incl. packaging) statutory value added tax and, in the case of export deliveries, all customs duties and fees as well as other public dues.
3. Insofar as agreed prices are based on the Seller's list prices and the delivery is to follow at least 3 months after conclusion of contract, the list price effective at the point of delivery shall apply (minus any agreed percentage or fixed discount).
4. Should, in the period between conclusion of contract and performance, a statutory change in sales tax enter into force, the Seller shall be entitled to invoice at the changed rate of sales tax, also with respect to permissible part deliveries.
5. With respect to all orders -- also orders on demand and successive delivery contracts -- for which, in accordance with contract or at the request of the orderer, delivery is made later than 3 months after placement of order, the Seller shall be entitled to pass on increases in material and wage costs occurring in this period to the Buyer. These increases shall be passed on to the extent that they are incurred.
6. The Seller shall not be bound to maintain the above prices in case of independent follow-on orders. Any price reductions introduced shall not apply with retrospective effect, but shall apply only prospectively as of the date of announcement of the respective reduction.
7. Invoice sums shall be payable within 10 days at a 2% discount or within 30 days without discount as of the date of invoice, at the very latest 30 days after maturity and receipt of service without deduction for postage and expenses. Decisive for date of payment shall be receipt by the Seller. Cheques shall be deemed payment upon redemption. Should the Buyer fail to make payment by the invoice maturity date, outstanding sums shall incur interest at a rate of 5% p.a. calculated as per maturity date. The right to assert a higher rate of interest and further damages in case of default, in accordance with statutory provisions, shall remain unaffected.
8. Fees and surcharges of any kind, as well as invoiced amounts for additional or special services (see III.1) are not qualifying for discount.
9. Set-off against claims of the Buyer or a right of retention with respect to payments on account of these claims shall only be permissible where these claims are undisputed or whose existence has been affirmed in a declaratory judgement.
10. The Seller shall be entitled to make deliveries/render services only against prior payment or security where, after conclusion of contract, circumstances become known which are capable of considerably reducing the creditworthiness of the Principal/Buyer and which are likely to jeopardise the payment of sums payable to the Seller by the Principal under the respective contract relationship (including other individual contracts for which the same framework agreement applies).
11. Small orders, under a net invoice value of € 150.00 in continental Europe and € 250.00 in the rest of the world, shall be subject to an administration fee of € 25.00 per small order. Replacement orders shall be excluded from this rule.
12. The Seller shall be entitled to assign its existing claims against the Buyer for the deliveries made or services rendered to third parties for the purpose of finance.

IV. Delivery and Delivery Time

1. In the absence of any express agreement to the contrary, all deliveries shall be made ex works (D-57399 Kirchhundem [M6]).
2. Deadlines and dates for delivery and services stipulated by the Seller shall be approximate only unless a fixed deadline or date has been expressly promised or agreed. Where dispatch has been agreed, delivery deadlines and dates shall refer to the date of transfer to the logistics provider, freight carrier or other third party charged with transport. In case of subsequent amendment to order, the Seller shall be released from the originally agreed delivery dates.

Terms and conditions

- Irrespective of rights arising from any default of the Buyer, the Seller shall be entitled to demand an extension of delivery/service deadlines or postponement of delivery/service dates by a period equal in length to the default by the Buyer.
- The Seller shall not be liable in case of frustration of delivery or for delays in delivery where these are caused through force majeure or other events which were not foreseeable at the time of conclusion of contract and for which the Seller is not responsible (e.g. interruption of operations of any kind, difficulties in acquiring materials or energy, transport delays, strikes, lawful lock-outs, lack of labour, energy or raw materials, difficulties in the procurement of necessary official authorisations, official measures or failure or delay in delivery by suppliers). Insofar as such events make it considerably more difficult or even impossible for the Seller to make delivery or render services and where the impairment to performance of contract is not only temporary, the Seller shall be entitled to rescind the contract either in full or in part. A pre-requisite for rescission on these grounds is, however, that the Seller notify the Buyer of the relevant circumstances and that it reimburse any sums paid by the Buyer in relation to any outstanding services of the Seller. In case of temporary impairment to performance, the deadlines or dates for delivery or service shall be extended by a period equal in length to the duration of the impairment plus an appropriate run-up period. Should it be unreasonable to expect the Principal to take delivery or accept the service after such delays, it shall be entitled to rescind the contract by way of immediate issue of written declaration of rescission to the Seller.
- The Seller shall only be entitled to make part deliveries where part deliveries are of value to the Principal within the scope of the contract purpose, the delivery of the remainder is assured and the Principal does not incur considerable additional expense as a result, except in the case that the Seller agrees to assume these additional costs. Should the Seller be late with a delivery or service or should it become impossible to make the delivery/render the service, for whatever reason, the Seller's liability for damages shall be restricted in accordance with Point VIII. of these General Terms and Conditions.

V. Place of Performance, Dispatch, Packaging, Transfer of Risk

- In the absence of any express agreement to the contrary, place of performance for all obligations arising under this contract relationship shall be the Seller's works in 57399 Kirchhundem/Germany.
- The type of dispatch and packaging shall be chosen at the reasonable discretion of the Seller. Usual packaging shall be the smallest packaging unit indicated in the catalogue. On ordering different amounts, the nearest packaging unit shall be delivered.
- Risk shall pass to the Buyer at the very latest upon the object for delivery being passed to the logistics provider, freight carrier or only third party charged with transport. The beginning of loading shall be decisive in determining when the object is passed. This shall also apply with respect to part deliveries or where the Seller has agreed to provide other services (e.g. dispatch). Where dispatch or transfer is delayed as a result of a circumstance whose cause rests with the Principal, risk shall pass to the Principal on the day the delivery object is made available for delivery and the Seller has notified this to the Buyer.
- Storage costs after transfer of risk shall be borne by the Principal. In case of storage provided by the Seller, storage costs shall be 0.25% of the invoice value of the delivery objects to be stored per each full week. It shall remain open to the contracting parties to assert and prove higher or lower storage costs.
- The consignment shall be insured by the Seller only on the express wish of the Buyer. Insurance shall be provided against theft, breakage, damage through transport, fire or water or other insurable risks. The cost of insurance shall be borne by the Buyer.
- With respect to contracts with repeated successive deliveries, the structure of delivery shall be indicated to the Seller in good time. Where deliveries are not called on time, the Seller shall be entitled, after expiry of a suitable grace period indicated to the Buyer, to structure and make the deliveries itself or to withdraw from the relevant part of the contract subject to the further conditions in Point IV. 4. and to claim damages for loss of profits. The right of the Seller to assert further damages shall remain unaffected.
- Returns not based on material defects or defects in title shall be processed in accordance with the Seller's conditions of return. These can be read at www.mennekes.de under General Terms and Conditions.

Terms and conditions

VI. Warranty, Material Defects

1. Irrespective of the duties of inspection and notification (§ 377 HGB (German Commercial Code)) which exist in respect of any bilateral trade, the Principal shall be bound to inspect the delivery for manifest defects and to issue notices with respect to such manifest defects – this shall also apply for incomplete or incorrect deliveries. Notice of defect shall be issued within 5 working days after receipt of goods. With respect to latent defects, notice of defect shall be issued within 5 days of the defect becoming apparent. Notice of defect shall be made in writing. Failure to issue notice of defect within the stipulated period shall result in the goods being deemed to have been approved and the Principal losing any right of recourse with respect to the defect against the Seller. At the request of the Seller, the queried delivery object shall be returned to the Seller with carriage paid. In case of legitimate notice of defect, the Seller shall reimburse the cost of cheapest return transport; this shall not apply where costs are higher because the delivery object is being used at a location other than that stipulated for use.
2. In case of legitimate notice of defect, the Seller, at its own option, shall be bound and entitled, within a reasonable period, to repair the defect or make a replacement delivery (secondary performance). In case secondary performance fails, that is, it is impossible or unreasonable, the Seller refuses to make secondary performance or secondary performance is subject to unreasonable delays, the Buyer shall be entitled to rescind the contract or make an appropriate reduction to the purchase price.
3. Where the defect is the fault of the Seller, the Buyer shall be entitled to assert a claim for damages under the conditions set down in VIII.
4. In case of defects in components made by other manufacturers which the Seller cannot remove, either for licence or physical reasons, the Seller shall, at its option, either assert its warranty rights against the manufacturer and supplier on the Principal's account, or shall assign these rights to the Principal. Warranty claims against the Seller with respect to such defects shall exist in accordance with these General Terms and Conditions only where legal proceedings against the manufacturer and supplier were unsuccessful or where such legal proceedings have no prospect of success, for instance due to the defendant's insolvency. For the duration of the legal dispute, the limitation period of the respective warranty shall be stayed.
5. The warranty shall lapse where the Principal tampers with the delivery object without the Seller's consent, or where a third party tamper with the delivery object at the Principal's behest, and the removal of defect is made impossible or unreasonable to the Seller as a result. The Principal shall bear all additional costs of the removal of defect as may arise as a result of the tampering.
6. Claims for defects shall not arise where the error occurs through the non-adherence to operating, storage, maintenance or installation instructions, unsuitable or improper use, wrong or negligent use by the Principal or naturally occurring wear and tear. The same shall apply where the Seller's products are improperly mounted, negligently handled or subjected to undue strain, or where disruption arises as a result of unsuitable operating means, substitute materials or mechanical, chemical, electro-chemical or electrical effects.
7. Any individual agreement with the Principal to supply used objects shall be to the exclusion of all warranty for material defects except in the case that such defects are maliciously suppressed by the Seller.
8. Legitimate defects on only part of the delivery shall not justify a complaint with respect to the entire delivery.

VII. Protected Rights

1. In accordance with Point VII., the Seller shall warrant that the object of delivery shall be free of third party industrial property rights or copyright in the country (state) or the agreed place of delivery. In the absence of any express written agreement to the contrary, the place of delivery shall be Kirchhundem/Germany. Each contracting partner shall notify the other immediately and in writing in case any claims for infringement of such rights are asserted. The rule in sentence 1 shall form no warranty, but shall represent an agreement as to quality pursuant to applicable warranty regulations.

Terms and conditions

2. In the case that the object of delivery infringe third party property rights or copyright, the Seller shall, at its own option, amend or exchange the object, such that it no longer infringe such rights yet still fulfil the contractually agreed functions, or shall furnish the Principal with the appropriate right of use by way of licence. Should the Seller not be able to resolve the problem within a reasonable period of time, the Principal shall be entitled to rescind the contract or reduce the purchase price accordingly. Any damage claims arising to the Principal against the Seller shall be subject to the restrictions of Point VIII of these General Terms and Conditions.
3. In case of legal infringements resulting from products delivered by the Seller but manufactured by other manufacturers, the Seller shall, at its own option, assert claims against the manufacturer or supplier on behalf of the Principal or shall assign these claims to the Principal. In these cases, claims against the Seller shall only exist where legal proceedings against the manufacturer or suppliers were unsuccessful or have no prospect of success, for instance because of the manufacturer's/supplier's insolvency.
4. Where deliveries are made in accordance with specific sketches or other indications made by the Principal and where these deliveries infringe third party rights, the Principal shall bear the responsibility for correctness and for ensuring that third party rights are not infringed. The Principal shall indemnify the Seller against all claims brought for breach of third party property rights. In the case of damage claims, the indemnity shall only be where the Buyer fail to prove that it is not responsible for the deficiency in its indications or the infringement of third party rights. If, in such a case, the Seller is prohibited from manufacturing or delivering the respective goods by a third party asserting its own property rights, the Seller shall be entitled to discontinue works and rescind the contract. Before doing so, the Seller must, however, issue notice to the Buyer setting a grace period during which the Buyer is required to have the prohibition removed by the third party. The assertion of a corresponding claim for damages by the Seller against the Buyer on the basis of other statutory provisions shall remain unaffected.

VIII. Other Liability (Limitation and Exclusion)

1. Liability of the Seller for damages, for whatever legal reason, in particular for frustration, delay, defective or wrong delivery, breach of contract, breach of duty of care in contractual negotiations and in tort, where fault is established, shall be limited by the following rules.
2. The Seller shall not be liable in case of negligence simpliciter of its corporate bodies, legal representatives, employees or other vicarious agents unless this involves a breach of essential contract duties (main duties under contract / cardinal duties). Essential contract duties are those duties which must be fulfilled in order that the contract be performed at all and which may regularly be relied upon by the contracting party.
3. Insofar as the Seller is liable for damages under the above sentence, liability shall be limited to damage which the Seller foresaw on conclusion of contract as a possible consequence of breach of contract or which it would have foreseen on exercise of due caution. Indirect or consequential damage resulting from defects in the object of delivery shall only be compensated where such damage can be typically expected on proper use of the object of delivery.
4. In case of liability for negligence simpliciter, the Seller's duty to pay compensation for property damage and pecuniary damage resulting therefrom shall be limited to damage which is usually and typically insurable by the Seller through liability / product liability insurance on reasonable terms, even where the matter relates to a breach of essential contract duties.
5. The above exclusions and limitations of liability shall apply to the same extent to the benefit of corporate bodies, legal representatives, employees and other vicarious agents of the Seller.
6. Insofar as the Seller provide technical information or acts in an advisory capacity and this information or advice does not form part of the services agreed and owed under contract, this information or advice shall be provided free of charge and the Seller shall not be liable for the information or advice.
7. The limitations on liability contained in this Point VIII shall not apply to liability of the Seller for deliberate acts, for warranted characteristics, for injury to life, body or health or to liability under the German Product Liability Act.

Terms and conditions

IX. Limitation Periods

1. Claims arising under Point VI shall be subject to a limitation period of one year beginning on delivery to the Buyer.
2. This shall not apply to the following claims which shall be subject to statutory limitation periods
 - Claims involving deliberate, malicious or grossly negligent breach of duty by the Seller, its legal representatives or vicarious agents;
 - Claims for damage resulting from injury to life, body or health due to a negligent breach of the Seller or from a deliberate or negligent breach of its legal representatives or vicarious agents;
 - Claims under a warranty for a certain characteristic;
 - Insofar as the supplier is so obliged, claims for reimbursement of costs which the Principal has to bear as against a subcontractor in the supply chain on account of a sale of new goods for the purpose of secondary performance (§ 478(2) BGB);
 - In case goods delivered by the Seller have been used in accordance with their instructions for use in a construction project and they have caused a defect in that project and Part B of the German Construction Contract Procedures (Verdingungsordnung für Bauleistungen) do not apply to the contract relationship.
3. For all these cases, limitation periods shall be in accordance with statutory provisions. The statutory rules on staying of the limitation periods and new begin of deadlines shall remain unaffected. In case of damage claims under the Product Liability Act, statutory limitation periods shall apply, also in case of deliberate or grossly negligent breach.
4. Where the Seller is liable under VIII for damage for which liability insurance at reasonable conditions is usually and typically concluded, the limitation period shall also be one year.

X. Retention of Title

1. The Seller shall retain title to the object of delivery (conditional goods) until all claims against the Principal arising under the business relationship, including any future claims from concurrent or later contracts, are settled. In case of open invoice, the retention of title and all rights shall form security for the entire outstanding sum plus interest and costs. In case of pledge or other third party acts, the Principal shall notify the Seller immediately.
2. The Principal shall be entitled to process and sell on the object of delivery in the course of ordinary business. This authority shall end where the Principal fall into arrears, on suspension of payments or where insolvency proceedings are opened against its assets. It shall be bound to sell on the goods only under retention of title and to ensure that claims from the resale pass to the Seller in accordance with 5. and 6. The use of the conditional goods for the fulfilment of contracts for work and contracts for work and materials shall be deemed a resale for this purpose. Other dispositions with respect to the conditional goods, in particular pledge or transfer by way of security, shall be prohibited. Assignment of claims from transfer of the conditional goods shall be prohibited unless the assignment is by way of a factoring, duly notified to the Seller, and for which the proceeds exceed the value of the secured claim. Upon crediting of the proceeds of the factoring arrangement, the Seller's claim shall immediately become due.
3. Processing of the conditional goods shall not result in the Buyer acquiring ownership of the resulting object pursuant to § 950 BGB. Processing or restructuring of the goods shall not obligate the Seller. The processed or restructured goods shall continue to be conditional goods.
4. On processing, incorporation or mixing of conditional goods with other goods, the Seller shall become joint owner of the resulting product. The Seller's share shall stand in proportion to the invoice value of the conditional goods to the invoice value of the other goods used. Where the Seller's ownership rights are extinguished by the incorporation, mixing or processing, the Principal shall assign it appropriate ownership rights or liens on the new product in the ratio of the invoice value of the conditional goods to other goods used. Storage of the product shall be free of charge for the Seller. Joint ownership rights in goods shall be sufficient for these goods to be conditional goods.
5. Claims of the Principal arising from the resale of conditional goods shall hereby be assigned to the Seller. They shall serve as security to the same extent as retention of title in the conditional goods.

Terms and conditions

6. Where the conditional goods are resold by the Principal together with other goods, the Seller shall be assigned a claim from the resale in the ratio of the invoice value of the conditional goods to the invoice value of the other goods. In case of resale of goods in which the Seller has joint ownership rights pursuant to 4., a corresponding share of the claims shall be assigned.

7. At the request of the Seller, the Principal shall be bound to provide it with an exact listing of its claims with names and address of buyers, to notify the buyers of the assignments and to supply the Seller with all information necessary for assertion of its assigned claims. As soon as it fall into arrears with payment or its financial situation deteriorate, the Principal shall authorise the Seller to notify the buyers of the assignment and to recover on its claims itself. The Seller shall be entitled to demand an assessment of its assigned claims carried out by an appointed party using the Principal's accounts. The Principal shall furnish the Seller with a listing of all goods for which the Seller still holds title (conditional goods).

8. Should existing securities exceed the value of secured claims by more than 10%, the Seller shall be bound, at the request of the Principal, to release securities at its option, taking into account the interests of the Principal. In case of retention of title, the value of the securities shall be determined with reference to the invoice value of the goods as bought by the Principal from the Seller. In case of extended retention of title, the invoice value for the resale of the goods shall be decisive.

9. Since the Seller retains title to the goods, the Seller can demand return of the goods in case of rescission of contract. The Seller shall be entitled to declare rescission of contract, irrespective of the further conditions set down in § 323 BGB and in particular without the requirement of imposition of a grace period for payment, immediately upon the Principal's default. The same shall apply where the Principal suspend its payment or where insolvency proceedings are opened against its assets. All costs arising as a result of repossession of the object of delivery shall be borne by the Principal. The Seller shall be entitled to dispose of the property it has repossessed as it sees fit.

XI. Authority to Process Data

The Seller shall be entitled to process all data in connection with the business relationship with the Buyer within the scope of applicable statutory provisions.

XII. Concluding Provisions

1. Place of jurisdiction for any and all dispute arising in connection with the business relationship between the Seller and the Principal shall be, at the option of the Seller, Kirchhundem or the place of business of the Buyer. For claims against the Seller, exclusive place of jurisdiction shall be 57399 Kirchhundem. Mandatory statutory provisions on exclusive places of jurisdiction shall remain unaffected by this rule.

2. The relationship between the Seller and the Buyer shall be governed by the laws of the Federal Republic of Germany. The UN Convention on Contracts for the International Sale of Goods from 11.04.1980 (CISG) shall be excluded.

3. Insofar as the contract or these General Terms and Conditions contain lacunae, the parties shall agree the legally effective provision which they would have agreed in light of the economic purpose of contract and the purpose of these General Terms and Conditions had they recognised the lacunae at the time of conclusion of contract or these General Terms and Conditions.

Note pursuant to § 36 of the Consumer Discrimination Act (VSBG)

The seller / contractor is neither obliged nor willing to participate in dispute settlement proceedings in front of a consumer arbitration board as defined by § 36 VSBG.

Printing errors, amendments, errors excepted.

Status of October 2023

Index of part numbers

Part no.	Part no.	Part no.	Part no.	Part no.	Part no.	Part no.	Part no.	Part no.	Part no.	Part no.	Part no.	Part no.	Part no.	Part no.	Part no.
31	219A	331	365	418	656A	740	820	858	1141A	1341	1401	1464	1501	1646	1704
32	221A	332	367	419	661A	741	821	891	1142A	1342	1406	1466	1502	1647	1707
128A	222A	333	368	420	662A	742	824	903	1144A	1343	1408	1467	1503	1648	1708
129A	223A	334	372	421	663A	743	825	905	1145A	1344	1409	1468	1504	1649	1709
131A	227A	335	373	422	664A	744	826	913	1147A	1345	1410	1469	1505	1650	1710
132A	228A	336	379	577	668A	745	827	921	1150A	1346	1411	1471	1506	1651	1711
133A	229A	337	380	578	669A	746	828	1035	1151A	1347	1414	1472	1507	1657	1712
134A	230A	338	381	583	674A	747	829	1040	1152A	1348	1415	1473	1551	1661	1713
135A	231A	339	384	584	675A	748	830	1045	1154A	1349	1418	1474	1556	1667	1714
136A	232A	340	385	585	676A	749	831	1050	1155A	1365	1419	1475	1557	1668	1716
137	233A	341	391	591	677A	750	832	1055	1168	1366	1420	1476	1579	1669	1717
138	234A	342	392	596	707A	752	833	1060	1169	1367	1421	1477	1595	1671	1719
139	235A	343	393	597	708A	767	834	1065	1173	1384	1422	1478	1602	1672	1720
140	238A	344	394	598	710	768	835	1070	1217	1385	1423	1479	1603	1673	1721
142	239A	345	395	599	713A	800	836	1075	1247A	1386	1424	1480	1618	1674	1723
143	240A	347	396	603	714A	801	837	1080	1248A	1388	1425	1484	1619	1675	1724
204A	246A	348	397	604	715A	802	838	1081	1249A	1389	1426	1485	1631	1676	1725
205A	301	349	398	609	716A	803	839	1103	1252A	1390	1427	1486	1632	1677	1726
206A	311	352	399	610	720A	804	840	1107	1260A	1391	1436	1490	1633	1678	1727
208A	315	353	400	611	721A	806A	842	1123A	1261A	1392	1437	1491	1635	1679	1730
209A	318	354	402	612	728A	808A	843	1124A	1263A	1393	1455	1492	1637	1680	1733
211A	319	356	403	616	729A	811	844	1125A	1264A	1394	1456	1493	1638	1682	1734
212A	322	357	405	617	733	812	846	1127A	1265A	1395	1457	1494	1639	1688	1735
213A	325	358	406	622	734	813	847	1128A	1270	1396	1458	1495	1640	1693	1739
215A	327	360	407	623	735	814	853	1131	1271	1397	1460	1496	1641	1700	1740
216A	328	361	410	624	736	815	854	1136A	1272	1398	1461	1497	1642	1701	1741
217A	329	363	411	625	737	817	856	1137A	1273	1399	1462	1499	1643	1702	1742
218A	330	364	412	655A	738	819	857	1140A	1340	1400	1463	1500	1644	1703	1743

Index of part numbers

Part no.	Part no.	Part no.	Part no.	Part no.	Part no.	Part no.	Part no.	Part no.	Part no.	Part no.	Part no.	Part no.	Part no.	Part no.	Part no.
1745	1808	1861	2181A	2767A	3048	3192	3350	3600	3987	4233	5496	5959A	7219	7512	7634
1746	1809	1862	2212	2837	3049	3193	3356	3606	4101	4254	5497	6015A	7220	7515	7636
1747	1810	1864	2213	2840A	3052	3197	3368	3646	4102	4300	5613A	6059A	7221	7516	9104
1750	1813	1940	2255	2841	3053	3200	3380	3650	4103	4304	5615A	6062A	7222	7520	9105
1751	1814	1955	2296	2845	3055	3202	3385	3656	4105	4320	5618A	6077	7238	7521	9106
1752	1815	1959	2317	2852	3057	3217	3413	3657	4107	4322	5630A	6106	7241	7524	9120
1753	1816	1961	2324	2855	3058	3218	3420	3658	4108	4324	5633A	6262A	7242	7525	9121
1754	1820	1962	2359	2864	3059	3221	3424	3665	4110	4326	5635A	6571	7243	7526	9122
1755	1824	1967	2386	2869	3060	3230	3447	3704	4112	4340	5638A	6580	7244	7530	9123
1756	1825	1968	2400	2870	3066	3231	3450	3713AA	4113	4342	5640A	7000	7245	7531	9124
1757	1829	1972	2405	2873A	3070	3232	3451	3717	4115	4344	5641A	7007	7246	7534	9140
1786	1831	1975	2459	2883	3115P	3233AA	3452	3718	4117	4345	5643A	7050	7247	7535	9141
1787	1832	1978	2460	2917A	3126	3254	3454	3719	4118	4350	5679A	7102	7248	7536	9142
1788	1835	1980	2478	2973A	3134	3256	3460	3774	4119	4360	5690A	7119	7249	7538	9150
1790	1837	1981	2488A	2983A	3147	3266	3461	3775	4120	4362	5691A	7125	7250	7602	9151
1791	1838	1982	2511	2997A	3149	3283	3473	3776	4122	4364	5692A	7126	7251	7603	9152
1792	1842	1983	2546P	3008	3152	3306	3485	3777	4123	4370	5693A	7127	7289	7605	9170
1793	1844	1984	2576A	3010	3154	3319A	3507	3783	4125	4375	5695A	7128	7290	7607	9171
1795	1845	2007A	2617A	3011	3155	3322	3517	3784	4127	4377	5759A	7129	7292	7612	9172
1796	1848	2123A	2668	3028	3157	3331	3523	3790	4128	5012	5785	7130	7294	7613	9173
1797	1850	2139	2675	3030	3171	3338	3524	3913	4130	5014	5887A	7132	7296	7614	9181
1798	1851	2166	2676A	3032	3183	3339	3528	3914	4132	5016	5888A	7143	7306	7616	9182
1800	1852	2167	2684	3034	3186	3340	3566	3915	4133	5109A	5911A	7145	7307	7620	9300
1802	1856	2175B	2692	3035	3187	3341	3573	3916	4135	5110A	5925A	7146	7312	7621	9301
1803	1857	2176	2761P	3039	3188	3343	3575	3917	4137	5111A	5946A	7147	7313	7623	9302
1804	1858	2177A	2764A	3043	3189	3345	3581	3980	4140	5112A	5955A	7153	7503	7624	9304
1805	1859	2179A	2765A	3045	3190	3346	3583	3982	4204	5113A	5956A	7213	7504	7626	9321
1806	1860	2180A	2766A	3046	3191	3348	3590	3983	4219	5495	5957A	7218	7507	7629	9322

Index of part numbers

Part no.	Part no.	Part no.	Part no.	Part no.	Part no.	Part no.	Part no.	Part no.	Part no.	Part no.	Part no.	Part no.	Part no.	Part no.	Part no.
9323	10749	11060	11681	13219	13516	13575	13619	13650	14137P	14259	14555	14592	14637	14682	20462
9324	10751	11061	13101	13220	13517	13576	13620	13651	14201	14501	14556	14594	14638	15530	20463
9327	10754	11081	13102	13223	13518	13577	13621	13652	14202	14502	14557	14596	14639	15678	20970
9341	10755	11110	13105	13224	13519	13578	13622	13653	14203	14503	14558	14597	14640	15679	21160A
9342	10828	11111	13106	13225	13520	13579	13623	13654	14204	14504	14559	14599	14641	15680	21241
9343	10829	11131	13107	13226	13521	13580	13624	13655	14205	14505	14560	14601	14642	15681	22928
9350	10833	11160	13111	13227	13522	13581	13625	13656	14206	14506	14561	14604	14643	15682	22986
9351	10834	11161	13112	13236	13523	13582	13626	13657	14207	14507	14562	14605	14644	15683	22987
9352	10837	11162	13136	13237	13550	13583	13627	13658	14208	14508	14563	14606	14649	15696	22988
9371	10838	11180	13137	13238	13551	13584	13628	13659	14209	14509	14565	14608	14650	15738	23249
9372	10839	11181	13201	13239	13552	13585	13629	13660	14210	14510	14567	14609	14651	15739	23293A
9373	10840	11182	13202	13248	13553	13586	13630	13661	14211	14511	14572	14610	14652	15740	23432
9380	10841	11310	13203	13259	13554	13587	13631	13665	14212	14512	14573	14619	14653	15741	23433
9381	10842	11311	13204	13501	13555	13588	13632	13668	14213	14513	14574	14620	14654	17002	24210
9382	10843	11312	13205	13502	13556	13591	13633	13669	14214	14514	14575	14621	14655	17006	24563
9530	10844	11313	13206	13503	13557	13592	13634	13673	14215	14515	14576	14622	14656	17014	24660
9531	10845	11330	13207	13504	13558	13594	13635	13674	14216	14516	14577	14623	14657	17021	24670
9532	10846	11331	13208	13505	13559	13596	13636	13677	14217	14517	14578	14624	14658	17039	24674
9562	10853	11332	13209	13506	13560	13597	13637	13678	14218	14518	14579	14625	14659	17060	24675
9590	10863	11333	13210	13507	13561	13599	13638	13681	14219	14519	14580	14626	14660	17064	24685
9591	11010	11511	13211	13508	13562	13601	13639	13682	14220	14520	14581	14627	14665	20146A	24760
10081	11011	11512	13212	13509	13563	13604	13640	14101	14223	14521	14582	14628	14668	20147A	24770
10082	11012	11531	13213	13510	13564	13605	13641	14102	14224	14522	14584	14629	14669	20151	24774
10083	11013	11532	13214	13511	13565	13606	13642	14105	14225	14523	14585	14630	14673	20152	24775
10087	11030	11561	13215	13512	13567	13608	13643	14106	14226	14550	14586	14631	14674	20458	24785
10092	11031	11581	13216	13513	13572	13609	13644	14107	14227	14551	14587	14632	14677	20459	24870
10713	11032	11611	13217	13514	13573	13610	13645	14111	14237P	14553	14588	14635	14678	20460	24885
10718	11033	11661	13218	13515	13574	13613	13649	14112	14248	14554	14591	14636	14681	20461	24970

Index of part numbers

Part no.	Part no.	Part no.	Part no.	Part no.	Part no.	Part no.	Part no.	Part no.	Part no.
24985	70351	75067	75148	75320	94351GE	921312	960031	5612306G	8109264
25042	71062	75068	75173	75321	94354SI	930003	960051	5612406G	8617060
25056	75001	75069	75201	75322	94355GE	930011	960340	5612409G	8617073
25102	75002	75070	75202	75323	94550SI	930022	970001GE	5612506G	9500417
25405	75006	75073	75206	75324	94552RO	930027	970002	5612509G	9500706
25705	75007	75074	75211	75325	94553GE	930028	970004GE	5613304G	9500719
25748	75011	75075	75212	75326	96227	930031	970005	5613306G	9500722
27001	75012	75076	75216	75327	96489	930035	990606	5613404G	9500748
27002	75016	75077	75221	75328	96703	930520	990607	5613406G	15452000
27003	75017	75078	75222	75329	96705	930734	990608	5613409G	15453000
27004	75021	75080	75226	75330	900005	931237	990609	5613506G	
27005	75022	75081	75231	75331	900946	940005	990610	5613509G	
27006	75026	75091	75236	75332	910001	940016	990611	5614304G	
27007	75031	75096	75241	75333	910007	940018	990612	5614306G	
27008	75036	75101	75242	75334	910015	940027	990620	5614406G	
41000	75041	75106	75246	75335	910020	940028	990623	5614409G	
41342	75042	75111	75256	75336	910031	940030	990625	5614506G	
41452	75046	75116	75261	75337	910205	940286	990627	5614509G	
41455	75053	75121	75266	75338	910214	941137	997000	5701405G	
41482	75055	75126	75276	75339	910355	950004	997001	5704403G	
41489	75056	75131	75284	75389	920003	950020	5603405G	5714403G	
41492	75057	75136	75287	75398	920005	950022	5603505G	5812306T	
70007	75058	75142	75291	75441	920011	950031	5611304G	5812406T	
70025	75059	75143	75310	75448	920043	950033	5611306G	5812506T	
70029	75060	75144	75312	90839	920046	950041	5611406G	5814306T	
70033	75063	75145	75313	92658	920283	960004	5611409G	5814406T	
70049	75065	75146	75316	92893	920294	960005	5611506G	5814506T	
70350	75066	75147	75317	92917	920821	960019	5612304G	8109251	